

# PHILIPPINE BIDDING DOCUMENTS

(As Harmonized with Development Partners)

# Procurement of GOODS

Government of the Republic of the Philippines

## **SUPPLY, DELIVERY, INSTALLATION AND TESTING OF VARIOUS HEATED AIR MECHANICAL GRAIN DRYERS**

**(FY 2024 Early Procurement)  
(PHilMech-RCEF-23-11-31)**

Schedule of Activities:

Pre-Bidding Conference:

**November 28, 2023; 1:30PM**

Auditorium, PHilMech Main Office  
Science City of Muñoz, Nueva Ecija

Submission & Opening of Bids:

**December 14, 2023; 1:30PM**

Auditorium, PHilMech Main Office  
Science City of Muñoz, Nueva Ecija

**Sixth Edition  
July 2020**

# Preface

These Philippine Bidding Documents (PBDs) for the procurement of Goods through Competitive Bidding have been prepared by the Government of the Philippines for use by any branch, constitutional commission or office, agency, department, bureau, office, or instrumentality of the Government of the Philippines, National Government Agencies, including Government-Owned and/or Controlled Corporations, Government Financing Institutions, State Universities and Colleges, and Local Government Unit. The procedures and practices presented in this document have been developed through broad experience, and are for mandatory use in projects that are financed in whole or in part by the Government of the Philippines or any foreign government/foreign or international financing institution in accordance with the provisions of the 2016 revised Implementing Rules and Regulations of Republic Act No. 9184.

The Bidding Documents shall clearly and adequately define, among others: (i) the objectives, scope, and expected outputs and/or results of the proposed contract or Framework Agreement, as the case may be; (ii) the eligibility requirements of Bidders; (iii) the expected contract or Framework Agreement duration, the estimated quantity in the case of procurement of goods, delivery schedule and/or time frame; and (iv) the obligations, duties, and/or functions of the winning bidder.

Care should be taken to check the relevance of the provisions of the PBDs against the requirements of the specific Goods to be procured. If duplication of a subject is inevitable in other sections of the document prepared by the Procuring Entity, care must be exercised to avoid contradictions between clauses dealing with the same matter.

Moreover, each section is prepared with notes intended only as information for the Procuring Entity or the person drafting the Bidding Documents. They shall not be included in the final documents. The following general directions should be observed when using the documents:

- a. All the documents listed in the Table of Contents are normally required for the procurement of Goods. However, they should be adapted as necessary to the circumstances of the particular Procurement Project.
- b. Specific details, such as the “*name of the Procuring Entity*” and “*address for bid submission*,” should be furnished in the Instructions to Bidders, Bid Data Sheet, and Special Conditions of Contract. The final documents should contain neither blank spaces nor options.
- c. This Preface and the footnotes or notes in italics included in the Invitation to Bid, Bid Data Sheet, General Conditions of Contract, Special Conditions of Contract, Schedule of Requirements, and Specifications are not part of the text of the final document, although they contain instructions that the Procuring Entity should strictly follow.

- d. The cover should be modified as required to identify the Bidding Documents as to the Procurement Project, Project Identification Number, and Procuring Entity, in addition to the date of issue.
- e. Modifications for specific Procurement Project details should be provided in the Special Conditions of Contract as amendments to the Conditions of Contract. For easy completion, whenever reference has to be made to specific clauses in the Bid Data Sheet or Special Conditions of Contract, these terms shall be printed in bold typeface on Sections I (Instructions to Bidders) and III (General Conditions of Contract), respectively.
- f. For guidelines on the use of Bidding Forms and the procurement of Foreign-Assisted Projects, these will be covered by a separate issuance of the Government Procurement Policy Board.

# Table of Contents

<b>Glossary of Acronyms, Terms, and Abbreviations .....</b>	<b>4</b>
<b>Section I. Invitation to Bid.....</b>	<b>7</b>
<b>Section II. Instructions to Bidders.....</b>	<b>11</b>
1. Scope of Bid .....	12
2. Funding Information.....	12
3. Bidding Requirements .....	12
4. Corrupt, Fraudulent, Collusive, and Coercive Practices .....	12
5. Eligible Bidders.....	12
6. Origin of Goods .....	13
7. Subcontracts .....	13
8. Pre-Bid Conference .....	14
9. Clarification and Amendment of Bidding Documents .....	14
10. Documents comprising the Bid: Eligibility and Technical Components .....	14
11. Documents comprising the Bid: Financial Component .....	14
12. Bid Prices .....	15
13. Bid and Payment Currencies .....	15
14. Bid Security .....	16
15. Sealing and Marking of Bids .....	16
16. Deadline for Submission of Bids .....	16
17. Opening and Preliminary Examination of Bids .....	16
18. Domestic Preference .....	17
19. Detailed Evaluation and Comparison of Bids .....	17
20. Post-Qualification .....	17
21. Signing of the Contract .....	17
<b>Section III. Bid Data Sheet .....</b>	<b>18</b>
<b>Section IV. General Conditions of Contract .....</b>	<b>21</b>
1. Scope of Contract .....	22
2. Advance Payment and Terms of Payment .....	22
3. Performance Security .....	22
4. Inspection and Tests .....	22
5. Warranty .....	23
6. Liability of the Supplier .....	23
<b>Section V. Special Conditions of Contract .....</b>	<b>22</b>
<b>Section VI. Schedule of Requirements .....</b>	<b>30</b>
<b>Section VII. Technical Specifications .....</b>	<b>31</b>
<b>Section VIII. Checklist of Technical and Financial Documents .....</b>	<b>67</b>

# *Glossary of Acronyms, Terms, and Abbreviations*

**ABC** – Approved Budget for the Contract.

**BAC** – Bids and Awards Committee.

**Bid** – A signed offer or proposal to undertake a contract submitted by a bidder in response to and in consonance with the requirements of the bidding documents. Also referred to as *Proposal* and *Tender*. (2016 revised IRR, Section 5[c])

**Bidder** – Refers to a contractor, manufacturer, supplier, distributor and/or consultant who submits a bid in response to the requirements of the Bidding Documents. (2016 revised IRR, Section 5[d])

**Bidding Documents** – The documents issued by the Procuring Entity as the bases for bids, furnishing all information necessary for a prospective bidder to prepare a bid for the Goods, Infrastructure Projects, and/or Consulting Services required by the Procuring Entity. (2016 revised IRR, Section 5[e])

**BIR** – Bureau of Internal Revenue.

**BSP** – Bangko Sentral ng Pilipinas.

**Consulting Services** – Refer to services for Infrastructure Projects and other types of projects or activities of the GOP requiring adequate external technical and professional expertise that are beyond the capability and/or capacity of the GOP to undertake such as, but not limited to: (i) advisory and review services; (ii) pre-investment or feasibility studies; (iii) design; (iv) construction supervision; (v) management and related services; and (vi) other technical services or special studies. (2016 revised IRR, Section 5[i])

**CDA** - Cooperative Development Authority.

**Contract** – Refers to the agreement entered into between the Procuring Entity and the Supplier or Manufacturer or Distributor or Service Provider for procurement of Goods and Services; Contractor for Procurement of Infrastructure Projects; or Consultant or Consulting Firm for Procurement of Consulting Services; as the case may be, as recorded in the Contract Form signed by the parties, including all attachments and appendices thereto and all documents incorporated by reference therein.

**CIF** – Cost Insurance and Freight.

**CIP** – Carriage and Insurance Paid.

**CPI** – Consumer Price Index.

**DDP** – Refers to the quoted price of the Goods, which means “delivered duty paid.”

**DTI** – Department of Trade and Industry.

**EXW** – Ex works.

**FCA** – “Free Carrier” shipping point.

**FOB** – “Free on Board” shipping point.

**Foreign-funded Procurement or Foreign-Assisted Project**– Refers to procurement whose funding source is from a foreign government, foreign or international financing institution as specified in the Treaty or International or Executive Agreement. (2016 revised IRR, Section 5[b]).

**Framework Agreement** – Refers to a written agreement between a procuring entity and a supplier or service provider that identifies the terms and conditions, under which specific purchases, otherwise known as “Call-Offs,” are made for the duration of the agreement. It is in the nature of an option contract between the procuring entity and the bidder(s) granting the procuring entity the option to either place an order for any of the goods or services identified in the Framework Agreement List or not buy at all, within a minimum period of one (1) year to a maximum period of three (3) years. (GPPB Resolution No. 27-2019)

**GFI** – Government Financial Institution.

**GOCC** – Government-owned and/or –controlled corporation.

**Goods** – Refer to all items, supplies, materials and general support services, except Consulting Services and Infrastructure Projects, which may be needed in the transaction of public businesses or in the pursuit of any government undertaking, project or activity, whether in the nature of equipment, furniture, stationery, materials for construction, or personal property of any kind, including non-personal or contractual services such as the repair and maintenance of equipment and furniture, as well as trucking, hauling, janitorial, security, and related or analogous services, as well as procurement of materials and supplies provided by the Procuring Entity for such services. The term “related” or “analogous services” shall include, but is not limited to, lease or purchase of office space, media advertisements, health maintenance services, and other services essential to the operation of the Procuring Entity. (2016 revised IRR, Section 5[r])

**GOP** – Government of the Philippines.

**GPPB** – Government Procurement Policy Board.

**INCOTERMS** – International Commercial Terms.

**Infrastructure Projects** – Include the construction, improvement, rehabilitation, demolition, repair, restoration or maintenance of roads and bridges, railways, airports, seaports, communication facilities, civil works components of information technology projects, irrigation, flood control and drainage, water supply, sanitation, sewerage and solid waste management systems, shore protection, energy/power and electrification facilities, national

buildings, school buildings, hospital buildings, and other related construction projects of the government. Also referred to as *civil works or works*. (2016 revised IRR, Section 5[u])

**LGUs** – Local Government Units.

**NFCC** – Net Financial Contracting Capacity.

**NGA** – National Government Agency.

**PhilGEPS** - Philippine Government Electronic Procurement System.

**Procurement Project** – refers to a specific or identified procurement covering goods, infrastructure project or consulting services. A Procurement Project shall be described, detailed, and scheduled in the Project Procurement Management Plan prepared by the agency which shall be consolidated in the procuring entity's Annual Procurement Plan. (GPPB Circular No. 06-2019 dated 17 July 2019)

**PSA** – Philippine Statistics Authority.

**SEC** – Securities and Exchange Commission.

**SLCC** – Single Largest Completed Contract.

**Supplier** – refers to a citizen, or any corporate body or commercial company duly organized and registered under the laws where it is established, habitually established in business and engaged in the manufacture or sale of the merchandise or performance of the general services covered by his bid. (Item 3.8 of GPPB Resolution No. 13-2019, dated 23 May 2019). Supplier as used in these Bidding Documents may likewise refer to a distributor, manufacturer, contractor, or consultant.

**UN** – United Nations

# ***Section I. Invitation to Bid***





**INVITATION TO BID**

***SUPPLY, DELIVERY, INSTALLATION AND TESTING OF VARIOUS HEATED AIR MECHANICAL GRAIN DRYERS***  
**(FY 2024 Early Procurement)**  
 (PHilMech-RCEF-23-11-31)

1. The **Philippine Center for Postharvest Development and Mechanization (PHilMech)** through its **FY 2024 Rice Competitive Enhancement Fund (RCEF)** intends to apply the below-specified amounts, being the Approved Budget for the Contract (ABC) for each lot, as indicated herein to payments under the contract for the **SUPPLY, DELIVERY, INSTALLATION AND TESTING OF VARIOUS HEATED AIR MECHANICAL GRAIN DRYERS**. Bids received in excess of the ABC of each Lot shall be automatically rejected during Bid opening.

<b>LOT NO.</b>	<b>PROJECT TITLE</b>	<b>ABC (PhP)</b>	<b>COST OF BIDDING DOCUMENTS (PhP)</b>
1	Supply, Delivery, Installation and Testing of 14 units Heated Air Mechanical Grain Dryers- Recirculating Batch Type (6 tons capacity) with Biomass and Petroleum Based Fuel Heating System for Region I	53,510,450.00	20,000.00
2	Supply, Delivery, Installation and Testing of 16 units Heated Air Mechanical Grain Dryers- Recirculating Batch Type (6 tons capacity) with Biomass and Petroleum Based Fuel Heating System for Regions II & III	61,154,800.00	20,000.00
3	Supply, Delivery, Installation and Testing of 21 units Heated Air Mechanical Grain Dryers- Recirculating Batch Type (6 tons capacity) with Biomass and Petroleum Based Fuel Heating System for Regions IVB, V, VI, VII & VIII	81,245,675.00	25,000.00
4	Supply, Delivery, Installation and Testing of 18 units Heated Air Mechanical Grain Dryers- Recirculating Batch Type (6 tons capacity) with Biomass and Petroleum Based Fuel Heating System for Regions X, XI, XII & CARAGA	68,799,150.00	20,000.00

5	Supply, Delivery, Installation and Testing of 10 units Heated Air Mechanical Grain Dryers- Recirculating Batch Type (12 tons capacity) with Biomass and Petroleum Based Fuel Heating System for Regions II, III & V	46,373,000.00	20,000.00
	ALL LOTS	<b>311,083,075.00</b>	<b>50,000.00</b>

2. The **PHilMech** now invites bids from eligible bidders for the **SUPPLY, DELIVERY, INSTALLATION AND TESTING OF VARIOUS HEATED AIR MECHANICAL GRAIN DRYERS**. Delivery of the GOODS is required within **One Hundred Twenty (120) calendar days** from receipt of the Notice to Proceed. Bidders should have completed within ten (10) years from the date of submission and receipt of bids a contract similar to the project. For this purpose, a similar contract shall refer to any contract for the **Supply and Delivery of Agricultural Machine/s**.

3. Bidding will be conducted through open competitive bidding procedures using non-discretionary pass/fail criteria as specified in the 2016 Revised Implementing Rules and Regulations (IRR-A) of Republic Act 9184 (R.A. 9184), otherwise known as the “Government Procurement Reform Act”.

Bidding is restricted to Filipino citizens/sole proprietorships, partnerships, or organizations with at least sixty percent (60%) interest or outstanding capital stock belonging to citizens of the Philippines, and to citizens or organizations of a country the laws or regulations of which grant similar rights or privileges to Filipino citizens, pursuant to RA 5183

4. Interested Bidders may obtain further information from the **PHilMech** and inspect the Bidding Documents at the address given below from 8:00 am to 5:00 pm.

5. A complete set of Bidding Documents may be acquired by interested Bidders during office hours from **November 21 to December 14, 2023** from the address given below upon payment of the applicable fee for the Bidding Documents as specified for each lot above.

Bidders may also opt to deposit in cash the applicable fee to the PHilMech’s Official Bank Account: Landbank of the Philippines (LBP) Account Name: PHILMECH TRUST FUND; Account No. 2962-1023-63 and by presenting or sending the proof of payment e.g. bank deposit slips to the address written below or email to bac@philmech.gov.ph subject to the condition that the bank service charge will be shouldered by the bidder.

The Bidding Documents may also be downloaded free of charge from the website of the Philippine Government Electronic Procurement System (PhilGEPS) and the website of the Procuring Entity provided that Bidders shall pay the applicable fee for the Bidding Documents before the submission of their Bids.

6. The **PHilMech** will hold a Pre-Bid Conference on **November 28, 2023; 1:30PM** at the **Auditorium, PHilMech Main Office, CLSU Compound, Science City of Muñoz, Nueva Ecija**, which shall be open to prospective bidders.

Interested bidders may opt to attend via video conferencing and pre-register on the email address provided below to signify their intention to participate. A Personal Meeting ID shall be provided to the authorized representative upon registration.

7. Bids must be duly received by the BAC Secretariat through manual submission at the address indicated below on or before **1:30PM of December 14, 2023**. Late Bids shall not be accepted.

8. All Bids must be accompanied by a bid security in any of the acceptable forms and in the amount stated in **ITB** Clause 14.
9. Bid opening shall be on **December 14, 2023; 1:30PM** at the address given below. Bids will be opened in the presence of the bidders' representatives who choose to attend the activity.
10. The **PHilMech** reserves the right to reject any and all bids, declare a failure of bidding, or not award the contract at any time prior to contract award in accordance with Section 35.6 and Section 41 of RA9184 and its IRR and GPPB Resolution No. 09-2020 without thereby incurring any liability to the affected bidder or bidders.
12. For further information, please contact:  
The BAC Secretariat,  
PHilMech Administrative Division-Procurement Management Section  
CLSU Compound, Science City of Muñoz, Nueva Ecija  
Contact No. 0917 301 8242  
E-mail: [bac@philmech.gov.ph](mailto:bac@philmech.gov.ph)
13. Interested bidders may also visit the following websites:  
For downloading of Bidding Documents:  
[www.philmech.gov.ph](http://www.philmech.gov.ph)  
<https://old.philmech.gov.ph/?page=bidding>

**NELSON C. SANTIAGO, Ph.D.**  
BAC Chairperson

**NOTICE/ANNOUNCEMENT**

PHILMECH DOES NOT CONDONE ANY FORM OF SOLICITATION FROM ANY PROSPECTIVE BIDDER BY ANY OF ITS STAFF/EMPLOYEE OR BY ANY OTHER PARTY. ANY ACTIVITY OF THIS NATURE MAY BE IMMEDIATELY REPORTED TO THE OFFICE OF THE DIRECTOR OR TO ANY APPROPRIATE LAW ENFORCEMENT AGENCY FOR ENTRAPMENT AND/OR INVESTIGATION.

## ***Section II. Instructions to Bidders***

## 1. Scope of Bid

The Procuring Entity, *Philippine Center for Postharvest Development and Mechanization (PHilMech)* wishes to receive Bids for the **SUPPLY, DELIVERY, INSTALLATION AND TESTING OF VARIOUS HEATED AIR MECHANICAL GRAIN DRYERS**, with identification number (*PHilMech-RCEF-23-11-31*).

The Procurement Project **SUPPLY, DELIVERY, INSTALLATION AND TESTING OF VARIOUS HEATED AIR MECHANICAL GRAIN DRYERS** is composed of *five (5) lots*, the details of which are described in Section VII (Technical Specifications)

## 2. Funding Information

2.1. The GOP through the source of funding as indicated below for **FY 2024** in the amount of **Php 311,083,075.00**

2.2. The source of funding is **NGA, the National Expenditure Program**

## 3. Bidding Requirements

The Bidding for the Project shall be governed by all the provisions of RA No. 9184 and its 2016 revised IRR, including its Generic Procurement Manuals and associated policies, rules and regulations as the primary source thereof, while the herein clauses shall serve as the secondary source thereof.

Any amendments made to the IRR and other GPPB issuances shall be applicable only to the ongoing posting, advertisement, or **IB** by the BAC through the issuance of a supplemental or bid bulletin.

The Bidder, by the act of submitting its Bid, shall be deemed to have verified and accepted the general requirements of this Project, including other factors that may affect the cost, duration and execution or implementation of the contract, project, or work and examine all instructions, forms, terms, and project requirements in the Bidding Documents.

## 4. Corrupt, Fraudulent, Collusive, and Coercive Practices

The Procuring Entity, as well as the Bidders and Suppliers, shall observe the highest standard of ethics during the procurement and execution of the contract. They or through an agent shall not engage in corrupt, fraudulent, collusive, coercive, and obstructive practices defined under Annex "I" of the 2016 revised IRR of RA No. 9184 or other integrity violations in competing for the Project.

## 5. Eligible Bidders

5.1. Only Bids of Bidders found to be legally, technically, and financially capable will be evaluated.

- 5.2. Foreign ownership exceeding those allowed under the rules may participate pursuant to:
- i. When a Treaty or International or Executive Agreement as provided in Section 4 of the RA No. 9184 and its 2016 revised IRR allow foreign bidders to participate;
  - ii. Citizens, corporations, or associations of a country, included in the list issued by the GPPB, the laws or regulations of which grant reciprocal rights or privileges to citizens, corporations, or associations of the Philippines;
  - iii. When the Goods sought to be procured are not available from local suppliers; or
  - iv. When there is a need to prevent situations that defeat competition or restrain trade.
- 5.3. Pursuant to Section 23.4.1.3 of the 2016 revised IRR of RA No.9184, the Bidder must have:
- i. **Completed at least two (2) similar contracts, the aggregate amount of which should be equivalent to at least fifty percent (50%) of the ABC for this Project; and**
  - ii. **The largest of these similar contracts must be equivalent to at least half of the percentage of the ABC as required above.**
- 5.4. The Bidders shall comply with the eligibility criteria under Section 23.4.1 of the 2016 IRR of RA No. 9184.

## 6. Origin of Goods

There is no restriction on the origin of goods other than those prohibited by a decision of the UN Security Council taken under Chapter VII of the Charter of the UN, subject to Domestic Preference requirements under **ITB** Clause 18.

## 7. Subcontracts

- 7.1. The Bidder may subcontract portions of the Project to the extent allowed by the Procuring Entity as stated herein, but in no case more than twenty percent (20%) of the Project.

The Procuring Entity has prescribed that Subcontracting is not allowed.

- 7.2. Subcontracting of any portion of the Project does not relieve the Supplier of any liability or obligation under the Contract. The Supplier will be responsible for the acts, defaults, and negligence of any subcontractor, its agents, servants, or workmen as fully as if these were the Supplier's own acts, defaults, or negligence, or those of its agents, servants, or workmen.

## 8. Pre-Bid Conference

The Procuring Entity will hold a pre-bid conference for this Project on the specified date and time and either **at the PHilMech Auditorium and/or video conferencing/webcasting** as indicated in paragraph 6 of the **IB**.

## 9. Clarification and Amendment of Bidding Documents

Prospective bidders may request for clarification on and/or interpretation of any part of the Bidding Documents. Such requests must be in writing and received by the Procuring Entity, either at its given address or through electronic mail indicated in the **IB**, at least ten (10) calendar days before the deadline set for the submission and receipt of Bids.

## 10. Documents comprising the Bid: Eligibility and Technical Components

- 10.1. The first envelope shall contain the eligibility and technical documents of the Bid as specified in **Section VIII (Checklist of Technical and Financial Documents)**.
- 10.2. The Bidder's SLCC as indicated in **ITB** Clause 5.3 should have been completed within **10 years** prior to the deadline for the submission and receipt of bids.
- 10.3. If the eligibility requirements or statements, the bids, and all other documents for submission to the BAC are in foreign language other than English, it must be accompanied by a translation in English, which shall be authenticated by the appropriate Philippine foreign service establishment, post, or the equivalent office having jurisdiction over the foreign bidder's affairs in the Philippines. Similar to the required authentication above, for Contracting Parties to the Apostille Convention, only the translated documents shall be authenticated through an apostille pursuant to GPPB Resolution No. 13-2019 dated 23 May 2019. The English translation shall govern, for purposes of interpretation of the bid.

## 11. Documents comprising the Bid: Financial Component

- 11.1. The second bid envelope shall contain the financial documents for the Bid as specified in **Section VIII (Checklist of Technical and Financial Documents)**.
- 11.2. If the Bidder claims preference as a Domestic Bidder or Domestic Entity, a certification issued by DTI shall be provided by the Bidder in accordance with Section 43.1.3 of the 2016 revised IRR of RA No. 9184.
- 11.3. Any bid exceeding the ABC indicated in paragraph 1 of the **IB** shall not be accepted.

- 11.4. For Foreign-funded Procurement, a ceiling may be applied to bid prices provided the conditions are met under Section 31.2 of the 2016 revised IRR of RA No. 9184.

## 12. Bid Prices

- 12.1. Prices indicated on the Price Schedule shall be entered separately in the following manner:
- a. For Goods offered from within the Procuring Entity's country:
    - i. The price of the Goods quoted EXW (ex-works, ex-factory, ex-warehouse, ex-showroom, or off-the-shelf, as applicable);
    - ii. The cost of all customs duties and sales and other taxes already paid or payable;
    - iii. The cost of transportation, insurance, and other costs incidental to delivery of the Goods to their final destination; and
    - iv. The price of other (incidental) services, if any, listed in e.
  - b. For Goods offered from abroad:
    - i. Unless otherwise stated in the **BDS**, the price of the Goods shall be quoted delivered duty paid (DDP) with the place of destination in the Philippines as specified in the **BDS**. In quoting the price, the Bidder shall be free to use transportation through carriers registered in any eligible country. Similarly, the Bidder may obtain insurance services from any eligible source country.
    - ii. The price of other (incidental) services, if any, as listed in **Section VII (Technical Specifications)**.

## 13. Bid and Payment Currencies

- 13.1. For Goods that the Bidder will supply from outside the Philippines, the bid prices may be quoted in the local currency or tradeable currency accepted by the BSP at the discretion of the Bidder. However, for purposes of bid evaluation, Bids denominated in foreign currencies, shall be converted to Philippine currency based on the exchange rate as published in the BSP reference rate bulletin on the day of the bid opening.
- 13.2. Payment of the contract price shall be made in Philippine Pesos.



## 14. Bid Security

- 14.1. The Bidder shall submit a Bid Securing Declaration<sup>1</sup> or any form of Bid Security in the amount indicated in the **BDS**, which shall be not less than the percentage of the ABC in accordance with the schedule in the **BDS**.
- 14.2. The Bid and bid security shall be valid until *April 12, 2024 or one hundred twenty (120) calendar days after the opening of bids in the event of a change in the date of the opening of bids*. Any Bid not accompanied by an acceptable bid security shall be rejected by the Procuring Entity as non-responsive.

## 15. Sealing and Marking of Bids

Each Bidder shall submit one copy of the first and second components of its Bid.

The Procuring Entity may request additional hard copies and/or electronic copies of the Bid. However, failure of the Bidders to comply with the said request shall not be a ground for disqualification.

If the Procuring Entity allows the submission of bids through online submission or any other electronic means, the Bidder shall submit an electronic copy of its Bid, which must be digitally signed. An electronic copy that cannot be opened or is corrupted shall be considered non-responsive and, thus, automatically disqualified.

## 16. Deadline for Submission of Bids

- 16.1. The Bidders shall submit on the specified date and time and either at its physical address or through online submission as indicated in paragraph 7 of the **IB**.

## 17. Opening and Preliminary Examination of Bids

- 17.1. The BAC shall open the Bids in public at the time, on the date, and at the place specified in paragraph 9 of the **IB**. The Bidders' representatives who are present shall sign a register evidencing their attendance. In case videoconferencing, webcasting or other similar technologies will be used, attendance of participants shall likewise be recorded by the BAC Secretariat.

In case the Bids cannot be opened as scheduled due to justifiable reasons, the rescheduling requirements under Section 29 of the 2016 revised IRR of RA No. 9184 shall prevail.

- 17.2. The preliminary examination of bids shall be governed by Section 30 of the 2016 revised IRR of RA No. 9184.

---

<sup>1</sup> In the case of Framework Agreement, the undertaking shall refer to entering into contract with the Procuring Entity and furnishing of the performance security or the performance securing declaration within ten (10) calendar days from receipt of Notice to Execute Framework Agreement.

## **18. Domestic Preference**

- 18.1. The Procuring Entity will grant a margin of preference for the purpose of comparison of Bids in accordance with Section 43.1.2 of the 2016 revised IRR of RA No. 9184.

## **19. Detailed Evaluation and Comparison of Bids**

- 19.1. The Procuring BAC shall immediately conduct a detailed evaluation of all Bids rated “*passed*,” using non-discretionary pass/fail criteria. The BAC shall consider the conditions in the evaluation of Bids under Section 32.2 of the 2016 revised IRR of RA No. 9184.
- 19.2. If the Project allows partial bids, bidders may submit a proposal on any of the lots or items, and evaluation will be undertaken on a per lot or item basis, as the case maybe. In this case, the Bid Security as required by **ITB** Clause 15 shall be submitted for each lot or item separately.
- 19.3. The descriptions of the lots or items shall be indicated in **Section VII (Technical Specifications)**, although the ABCs of these lots or items are indicated in the **BDS** for purposes of the NFCC computation pursuant to Section 23.4.2.6 of the 2016 revised IRR of RA No. 9184. The NFCC must be sufficient for the total of the ABCs for all the lots or items participated in by the prospective Bidder.
- 19.4. The Project shall be awarded as follows:  
  
**One Project having several items grouped into several lots, which shall be awarded as separate contracts per lot.**
- 19.5. Except for bidders submitting a committed Line of Credit from a Universal or Commercial Bank in lieu of its NFCC computation, all Bids must include the NFCC computation pursuant to Section 23.4.1.4 of the 2016 revised IRR of RA No. 9184, which must be sufficient for the total of the ABCs for all the lots or items participated in by the prospective Bidder. For bidders submitting the committed Line of Credit, it must be at least equal to ten percent (10%) of the ABCs for all the lots or items participated in by the prospective Bidder.

## **20. Post-Qualification**

- 20.2 Within a non-extendible period of five (5) calendar days from receipt by the Bidder of the notice from the BAC that it submitted the Lowest Calculated Bid, the Bidder shall submit its latest income and business tax returns filed and paid through the BIR Electronic Filing and Payment System (eFPS) and other appropriate licenses and permits required by law and stated in the **BDS**.

## **21. Signing of the Contract**

- 21.1. The documents required in Section 37.2 of the 2016 revised IRR of RA No. 9184 shall form part of the Contract. Additional Contract documents are indicated in the **BDS**.

## ***Section III. Bid Data Sheet***

# Bid Data Sheet

ITB Clause																									
5.3	<p>For this purpose, a contract similar to the project shall be:</p> <ol style="list-style-type: none"> <li>a. <i>Supply and Delivery of Agricultural Machine/s</i></li> <li>b. Completed, within the last 10 years prior to the deadline for the submission and receipt of bids. At least two (2) similar contracts, the aggregate amount of which should be equivalent to at least fifty percent (50%) of the ABC for this Project; and the largest of these similar contracts must be equivalent to at least half of the percentage of the ABC as required above. Bidders shall include in their bids:               <ol style="list-style-type: none"> <li>1. A photocopy of the Single Largest Completed Contract or Purchase Order; and</li> <li>2. The corresponding proof of completion, which could either be:                   <ol style="list-style-type: none"> <li>(i) Certificate of Final Acceptance from the bidder's client; or</li> <li>(ii) Official Receipt of the bidder covering the full amount of the contract</li> </ol> </li> </ol> <p>Failure to submit a copy of the Single Largest Completed Contract with proof of completion is a valid ground for disqualification of the bidder.</p> </li> </ol>																								
7.1	<i>Subcontracting is not allowed.</i>																								
12	No further instruction.																								
14.1	<p>The bid security shall be in the form of a Bid Securing Declaration, or any of the following forms and amounts:</p> <table border="1" style="width: 100%; border-collapse: collapse; margin: 10px 0;"> <thead> <tr> <th style="text-align: center;">LOT NO.</th> <th style="text-align: center;">ABC</th> <th style="text-align: center;">1. Bid Security in cash, cashier's/manager's check, bank draft/guarantee or irrevocable letter of credit (2% of the ABC)</th> <th style="text-align: center;">2. Bid Security in Surety Bond (5% of the ABC)</th> </tr> </thead> <tbody> <tr> <td style="text-align: center;">1</td> <td style="text-align: right;">53,510,450.00</td> <td style="text-align: right;">1,070,209.00</td> <td style="text-align: right;">2,675,522.50</td> </tr> <tr> <td style="text-align: center;">2</td> <td style="text-align: right;">61,154,800.00</td> <td style="text-align: right;">1,223,096.00</td> <td style="text-align: right;">3,057,740.00</td> </tr> <tr> <td style="text-align: center;">3</td> <td style="text-align: right;">81,245,675.00</td> <td style="text-align: right;">1,624,913.50</td> <td style="text-align: right;">4,062,283.75</td> </tr> <tr> <td style="text-align: center;">4</td> <td style="text-align: right;">68,799,150.00</td> <td style="text-align: right;">1,375,983.00</td> <td style="text-align: right;">3,439,957.50</td> </tr> <tr> <td style="text-align: center;">5</td> <td style="text-align: right;">46,373,000.00</td> <td style="text-align: right;">927,460.00</td> <td style="text-align: right;">2,318,650.00</td> </tr> </tbody> </table> <p>One Bid Security shall be submitted for each lot if the bid security is in the form of cash, cashier's/manager' check, bank draft/guarantee or irrevocable letter of credit or surety bond.</p>	LOT NO.	ABC	1. Bid Security in cash, cashier's/manager's check, bank draft/guarantee or irrevocable letter of credit (2% of the ABC)	2. Bid Security in Surety Bond (5% of the ABC)	1	53,510,450.00	1,070,209.00	2,675,522.50	2	61,154,800.00	1,223,096.00	3,057,740.00	3	81,245,675.00	1,624,913.50	4,062,283.75	4	68,799,150.00	1,375,983.00	3,439,957.50	5	46,373,000.00	927,460.00	2,318,650.00
LOT NO.	ABC	1. Bid Security in cash, cashier's/manager's check, bank draft/guarantee or irrevocable letter of credit (2% of the ABC)	2. Bid Security in Surety Bond (5% of the ABC)																						
1	53,510,450.00	1,070,209.00	2,675,522.50																						
2	61,154,800.00	1,223,096.00	3,057,740.00																						
3	81,245,675.00	1,624,913.50	4,062,283.75																						
4	68,799,150.00	1,375,983.00	3,439,957.50																						
5	46,373,000.00	927,460.00	2,318,650.00																						

19.3	LOT NO.	PROJECT TITLE	ABC (PhP)
	1	Supply, Delivery, Installation and Testing of 14 units Heated Air Mechanical Grain Dryers- Recirculating Batch Type (6 tons capacity) with Biomass and Petroleum Based Fuel Heating System for Region I	53,510,450.00
	2	Supply, Delivery, Installation and Testing of 16 units Heated Air Mechanical Grain Dryers- Recirculating Batch Type (6 tons capacity) with Biomass and Petroleum Based Fuel Heating System for Regions II & III	61,154,800.00
	3	Supply, Delivery, Installation and Testing of 21 units Heated Air Mechanical Grain Dryers- Recirculating Batch Type (6 tons capacity) with Biomass and Petroleum Based Fuel Heating System for Regions IVB, V, VI, VII & VIII	81,245,675.00
	4	Supply, Delivery, Installation and Testing of 18 units Heated Air Mechanical Grain Dryers- Recirculating Batch Type (6 tons capacity) with Biomass and Petroleum Based Fuel Heating System for Regions X, XI, XII & CARAGA	68,799,150.00
	5	Supply, Delivery, Installation and Testing of 10 units Heated Air Mechanical Grain Dryers- Recirculating Batch Type (12 tons capacity) with Biomass and Petroleum Based Fuel Heating System for Regions II, III & V	46,373,000.00
19.4	<b><i>Service of pertinent notices related to this bidding through Electronic Mail (e-mail) to the email address provided by the bidder shall be tantamount to proof of actual service and shall be deemed received by the bidder on the date of service or email.</i></b>		
20.2	<i>“No Additional Requirement”</i>		
21.1	<i>“No Additional Requirement”</i>		
21.2	<i>“Not Applicable”</i>		

## ***Section IV. General Conditions of Contract***

## 1. **Scope of Contract**

This Contract shall include all such items, although not specifically mentioned, that can be reasonably inferred as being required for its completion as if such items were expressly mentioned herein. All the provisions of RA No. 9184 and its 2016 revised IRR, including the Generic Procurement Manual, and associated issuances, constitute the primary source for the terms and conditions of the Contract, and thus, applicable in contract implementation. Herein clauses shall serve as the secondary source for the terms and conditions of the Contract.

This is without prejudice to Sections 74.1 and 74.2 of the 2016 revised IRR of RA No. 9184 allowing the GPPB to amend the IRR, which shall be applied to all procurement activities, the advertisement, posting, or invitation of which were issued after the effectivity of the said amendment.

Additional requirements for the completion of this Contract shall be provided in the **Special Conditions of Contract (SCC)**.

## 2. **Advance Payment and Terms of Payment**

2.1. Advance payment of the contract amount is provided under Annex “D” of the revised 2016 IRR of RA No. 9184.

2.2. The Procuring Entity is allowed to determine the terms of payment on the partial or staggered delivery of the Goods procured, provided such partial payment shall correspond to the value of the goods delivered and accepted in accordance with prevailing accounting and auditing rules and regulations. The terms of payment are indicated in the **SCC**.

## 3. **Performance Security**

Within ten (10) calendar days from receipt of the Notice of Award by the Bidder from the Procuring Entity but in no case later than prior to the signing of the Contract by both parties, the successful Bidder shall furnish the performance security in any of the forms prescribed in Section 39 of the 2016 revised IRR of RA No. 9184

## 4. **Inspection and Tests**

The Procuring Entity or its representative shall have the right to inspect and/or to test the Goods to confirm their conformity to the Project specifications at no extra cost to the Procuring Entity in accordance with the Generic Procurement Manual. In addition to tests in the **SCC, Section VII (Technical Specifications)** shall specify what inspections and/or tests the Procuring Entity requires, and where they are to be conducted. The Procuring Entity shall notify the Supplier in writing, in a timely manner, of the identity of any representatives retained for these purposes.

All reasonable facilities and assistance for the inspection and testing of Goods, including access to drawings and production data, shall be provided by the Supplier to the authorized inspectors at no charge to the Procuring Entity.

## 5. **Warranty**

- 5.1 In order to assure that manufacturing defects shall be corrected by the Supplier, a warranty shall be required from the Supplier as provided under Section 62.1 of the 2016 revised IRR of RA No. 9184.
- 5.2 The Procuring Entity shall promptly notify the Supplier in writing of any claims arising under this warranty. Upon receipt of such notice, the Supplier shall, repair or replace the defective Goods or parts thereof without cost to the Procuring Entity, pursuant to the Generic Procurement Manual.

## 6. **Liability of the Supplier**

The Supplier's liability under this Contract shall be as provided by the laws of the Republic of the Philippines.

If the Supplier is a joint venture, all partners to the joint venture shall be jointly and severally liable to the Procuring Entity.



## *Section V. Special Conditions of Contract*

## Special Conditions of Contract

GCC Clause	
1	<p><b>Delivery and Documents –</b></p> <p>For purposes of the Contract, “EXW,” “FOB,” “FCA,” “CIF,” “CIP,” “DDP” and other trade terms used to describe the obligations of the parties shall have the meanings assigned to them by the current edition of INCOTERMS published by the International Chamber of Commerce, Paris. The Delivery terms of this Contract shall be as follows:</p> <p>“The delivery terms applicable to this Contract are delivered <i>[indicate place of destination]</i>. Risk and title will pass from the Supplier to the Procuring Entity upon receipt and final acceptance of the Goods at their final destination.”</p> <p>Delivery of the Goods shall be made by the Supplier in accordance with the terms specified in Section VI (Schedule of Requirements).</p> <p>For purposes of this Clause, the Procuring Entity’s Representative at the Project Sites are as follows:</p> <p><i>Cluster 1 (Regions I and III)- Engr. Maritess Sobrevilla</i></p> <p><i>Cluster 2 (CAR and Region II) – Engr. Jarell S. Oting</i></p> <p><i>Cluster 3 (Regions IV-A, IV-B and V) – Engr. Nino D. Bengosta</i></p> <p><i>Cluster 4 (Regions VI, VII and VIII) –Engr. Domingo A. Miranda</i></p> <p><i>Cluster 5 (Regions IX, X and CARAGA) – Engr. Edgar A. Testa</i></p> <p><i>Cluster 6 (Regions XI, XII and BARMM) – Engr. Franklin D. Gomez</i></p> <p><b>Incidental Services –</b></p> <p>The Supplier is required to provide all of the following services, including additional services, if any, specified in Section VI. Schedule of Requirements: performance or supervision of on-site assembly and/or start-up of the supplied Goods;</p> <ol style="list-style-type: none"> <li>a. Furnishing of tools required for assembly and/or maintenance of the supplied Goods;</li> <li>b. Furnishing of a detailed operations and maintenance manual for each appropriate unit of the supplied Goods;</li> </ol>

c. Performance or supervision or maintenance and/or repair of the supplied Goods, for a period of time agreed by the parties, provided that this service shall not relieve the Supplier of any warranty obligations under this Contract; and

d. Training of the Procuring Entity's recipients, at the delivery site, on assembly, start-up, operation, maintenance, and/or basic repair of the supplied Farm Machineries.

e. Provision of palay sample for testing.

f. Furnishing of all other services required for compliance with the technical specifications.

The Contract price for the Goods shall include the prices charged by the Supplier for incidental services and shall not exceed the prevailing rates charged to other parties by the Supplier for similar services.

**Spare Parts –**

The Supplier is required to provide all of the following materials, notifications, and information pertaining to spare parts manufactured or distributed by the Supplier:

a. such spare parts as the Procuring Entity may elect to purchase from the Supplier, provided that this election shall not relieve the Supplier of any warranty obligations under this Contract; and

b. in the event of termination of production of the spare parts:

i. advance notification to the Procuring Entity of the pending termination, in sufficient time to permit the Procuring Entity to procure needed requirements; and

ii. following such termination, furnishing at no cost to the Procuring Entity, the blueprints, drawings, and specifications of the spare parts, if requested.

The spare parts and other components required are listed in **Section VI (Schedule of Requirements)** and the cost thereof are included in the contract price.

The Supplier shall carry sufficient inventories to assure ex-stock supply of consumable spare parts or components for the Goods for a period of [*indicate here the time period specified. If not used indicate a time period of three times the warranty period*].

Spare parts or components shall be supplied as promptly as possible, but in any case, within one month of placing the order.

**Packaging –**

The Supplier shall provide such packaging of the Goods as is required to prevent their damage or deterioration during transit to their final destination, as indicated in this Contract. The packaging shall be sufficient to withstand, without limitation, rough handling during transit and exposure to extreme temperatures, salt and precipitation during transit, and open storage. Packaging case size and weights shall take into consideration, where appropriate, the remoteness of the Goods' final destination and the absence of heavy handling facilities at all points in transit.

The packaging, marking, and documentation within and outside the packages shall comply strictly with such special requirements as shall be expressly provided for in the Contract, including additional requirements, if any, specified below, and in any subsequent instructions ordered by the Procuring Entity.

The outer packaging must be clearly marked on at least four (4) sides as follows:

- Name of the Procuring Entity
- Name of the Supplier
- Contract Description
- Final Destination
- Gross weight
- Any special lifting instructions
- Any special handling instructions
- Any relevant HAZCHEM classifications

A packaging list identifying the contents and quantities of the package is to be placed on an accessible point of the outer packaging if practical. If not practical the packaging list is to be placed inside the outer packaging but outside the secondary packaging.

	<p><b>Transportation –</b> Where the Supplier is required under Contract to deliver the Goods CIF, CIP, or DDP, transport of the Goods to the port of destination or such other named place of destination in the Philippines, as shall be specified in this Contract, shall be arranged and paid for by the Supplier, and the cost thereof shall be included in the Contract Price.</p> <p>Where the Supplier is required under this Contract to transport the Goods to a specified place of destination within the Philippines, defined as the Project Site, transport to such place of destination in the Philippines, including insurance and storage, as shall be specified in this Contract, shall be arranged by the Supplier, and related costs shall be included in the contract price.</p> <p>Where the Supplier is required under Contract to deliver the Goods CIF, CIP or DDP, Goods are to be transported on carriers of Philippine registry. In the event that no carrier of Philippine registry is available, Goods may be shipped by a carrier which is not of Philippine registry provided that the Supplier obtains and presents to the Procuring Entity certification to this effect from the nearest Philippine consulate to the port of dispatch. In the event that carriers of Philippine registry are available but their schedule delays the Supplier in its performance of this Contract the period from when the Goods were first ready for shipment and the actual date of shipment the period of delay will be considered force majeure.</p> <p>The Procuring Entity accepts no liability for the damage of Goods during transit other than those prescribed by INCOTERMS for DDP deliveries. In the case of Goods supplied from within the Philippines or supplied by domestic Suppliers risk and title will not be deemed to have passed to the Procuring Entity until their receipt and final acceptance at the final destination.</p> <p><b>Intellectual Property Rights –</b> The Supplier shall indemnify the Procuring Entity against all third-party claims of infringement of patent, trademark, or industrial design rights arising from use of the Goods or any part thereof.</p>
2.2	<p>The terms of payment shall be as follows:</p> <ol style="list-style-type: none"> <li>a. Fifty percent (50%) of the Contract Price: upon delivery of the complete components such as the pre-cleaner, heating system, drying bin, control panel, and the dust collection system conducted with initial inspection of the authorized representatives of PHilMech; and</li> <li>b. Remaining Fifty Percent (50%) of the Contract Price: upon 100% completion of the project, final inspection and acceptance, and submission of required documents.</li> </ol>

4	<p>All goods delivered under this contract shall be subject to the following test:</p> <ul style="list-style-type: none"> <li>• Technical inspection to determine their order and condition, quantity, compliance with the technical specifications and all other contract requirements;</li> <li>• Operational test upon delivery on-site;</li> <li>• Performance testing through random sampling.</li> </ul> <p>Prior notice of the schedule of such tests or inspections, written or verbal, will be given to the authorized representative of the Supplier. The inspection will push through as scheduled even in the absence of the Supplier’s representative, if the latter was duly notified, in which case, the results of the inspection conducted by the procuring Entity shall be final and binding upon the Supplier.</p>
5.1	<p>The Procuring Entity’s address for notice is bac@philmech.gov.ph</p> <p>The Bidder’s address for notice is the e-mail address indicated in the bidder’s Omnibus Sworn Statement (OSS)</p> <p>Service of pertinent notices related to this bidding through Electronic Mail (e-mail) to the email address provided by the bidder in the OSS shall be tantamount to proof of actual service and shall be deemed received by the bidder on the date of service or email.</p>

## *Section VI. Schedule of Requirements*

**RE: SUPPLY, DELIVERY, INSTALLATION AND TESTING OF VARIOUS HEATED AIR GRAIN DRYERS  
(PHilMech-RCEF-23-11-31)**

<b>Lot no/s. being bid:</b>  _____	<b>Name and Signature of Authorized Representative:</b>  _____
--	--

The delivery schedule expressed as weeks/months stipulates hereafter a delivery date which is the date of delivery to the project site.

<b>Item Number (LOT No.)</b>	<b>Project Title</b>	<b>Delivered, Weeks/Months</b>
1	Supply, Delivery, Installation and Testing of 14 units Heated Air Mechanical Grain Dryers- Recirculating Batch Type (6 tons capacity) with Biomass and Petroleum Based Fuel Heating System for Region I	120CD
2	Supply, Delivery, Installation and Testing of 16 units Heated Air Mechanical Grain Dryers- Recirculating Batch Type (6 tons capacity) with Biomass and Petroleum Based Fuel Heating System for Regions II & III	120CD
3	Supply, Delivery, Installation and Testing of 21 units Heated Air Mechanical Grain Dryers- Recirculating Batch Type (6 tons capacity) with Biomass and Petroleum Based Fuel Heating System for Regions IVB, V, VI, VII & VIII	120CD
4	Supply, Delivery, Installation and Testing of 18 units Heated Air Mechanical Grain Dryers- Recirculating Batch Type (6 tons capacity) with Biomass and Petroleum Based Fuel Heating System for Regions X, XI, XII & CARAGA	120CD
5	Supply, Delivery, Installation and Testing of 10 units Heated Air Mechanical Grain Dryers- Recirculating Batch Type (12 tons capacity) with Biomass and Petroleum Based Fuel Heating System for Regions II, III & V	120CD

\_\_\_\_\_  
Signature over Printed Name of Bidder

\_\_\_\_\_  
Position/Designation

\_\_\_\_\_  
(Name, Address & Tel. No. of Company)

\_\_\_\_\_  
Date

## ***Section VII. Technical Specifications***



# Technical Specifications

**RE: SUPPLY, DELIVERY, INSTALLATION AND TESTING OF VARIOUS HEATED AIR MECHANICAL GRAIN DRYERS**  
*(PHilMech RCEF-23-11-31)*

<p style="text-align: center;"><b>Lot no/s. being bid:</b></p> <hr style="width: 80%; margin: 0 auto;"/>	<p style="text-align: center;"><b>Name and Signature of Authorized Representative:</b></p> <hr style="width: 80%; margin: 0 auto;"/>
--	--

<b>SPECIFICATION</b>	<p style="margin: 0;"><b>Statement of Compliance*</b></p> <p style="margin: 0; font-size: small;">Bidders must state here either “Comply” or “Not Comply” against each of the individual parameters of each Specification stating the corresponding performance parameter of the equipment offered. Statements of “Comply” or “Not Comply” must be supported by evidence in a Bidders Bid and cross-referenced to that evidence. Evidence shall be in the form of manufacturer’s un-amended sales literature, unconditional statements of specification and compliance issued by the manufacturer, samples, independent test data etc., as appropriate. A statement that is not supported by evidence or is subsequently found to be contradicted by the evidence presented will render the Bid under evaluation liable for rejection. A statement either in the Bidders statement of compliance or the supporting evidence that is found to be false either during Bid evaluation, post-qualification or the execution of the Contract may be regarded as fraudulent and render the Bidder or supplier liable for prosecution subject to the applicable laws and issuance.</p>	<b>REFERENCE PAGE NO.</b>
<p><b>Supply, Delivery, Installation and Testing of Heated Air Mechanical Grain Dryer - Recirculating Batch Dryer (6 tons capacity) with Biomass and Petroleum Based Heating System</b></p>		
<p><b>Technical Specifications:</b></p>		

<b>Verifiable through AMTEC Test Report</b>		
- Cracked grain, % Increase: 3%, maximum		
- Head rice, % decrease: 5%, maximum		
- Hulled/damaged grain % increase: 2%, maximum		
- Drying Loss/Spillage: 1%, maximum		
- Holding capacity: 6 tons wet palay @ 24% moisture content, minimum		
- Moisture gradient: 2%, maximum		
- Drying efficiency: 75%, minimum		
- Drying rate: 0.8 %/hr, minimum		
<b>Verifiable during inspection</b>		
- With programmable in-line monitoring system		
• Moisture content		
• Temperature		
• Can control the heating system		
- With compatible single-phase electric motor for the drying system		
- Vertical rectangular bin		
• Consist of rectangular vertically installed drying chamber		
- With control panel		
• Mimic flow of operation		
• Basic electrical meter such as ammeter and voltmeter display		
• Basic safety cut-off features		
○ Emergency shutdown button		
○ On-off pilot lights switch button and indicating operating motor, each component with motor should have individual circuit breaker		
○ Magnetic starter with overload		
○ Interlocking system and emergency button		
- Construction: Stainless steel - SS 304 for the following parts such as:		
• Drying bin wall/cover		

• Discharge chute, 1.2mm, minimum		
• Elevator casing		
• Bottom boot section of the elevator		
• Drying Chamber: perforated screen for non-LSU type or inverted V-duct for LSU type		
• Auger		
• Auger Casing		
• Receiving hopper		
- Discharge pipe (supplier's standard)		
- Mounting frame		
• Steel angular bar (50mm x 50mm x 6mm, minimum)		
• Mounting frame shall be fitted with brackets for concrete floor installation		
<b>With the following components:</b>		
1. Heating system 1		
- Petroleum based fuel: Direct-fired		
- Heating system efficiency: 90%, minimum (Verifiable through AMTEC Test Report)		
With the following accessories:		
- Flame sensor		
- Electronic ignition system		
- Automatic fuel shut-off		
- Adjustable fuel vaporizer		
- Elevated non-corrosive and heat-resistant fuel container at 200li capacity, minimum		
- Compatible single-phase electric motor for the heating system		
2. Heating system 2		
- Biomass fuel: Indirect-fired		
- Heating system efficiency: 50%, minimum (Verifiable through AMTEC Test Report)		
- Heat exchanger: Stainless (SS 201, 1.2mm, minimum)/fire tubes (5mm seamless, minimum)		

- Burning chamber: Made of refractory bricks		
• With automatic fuel feeder, Auger type		
With the following accessories:		
- With temperature control		
- With compatible single-phase electric motor		
3. Pre-cleaner		
- Input capacity: 6ton/hr, minimum		
- Sieve mechanism: All parts that come in contact with the grain must be made of stainless steel 304		
- Capable of removing large impurities and unthreshed paddy		
- With compatible electric motor		
4. With provision of ducting to divert heat source from heating system 1 or heating system 2		
- Made of stainless steel or primer painted and powdered coated B.I. or G.I. sheet		
5. Dust collection system consists of cyclone separator/collector and suction blower. All ducting shall be fabricated from sheet metal and the connectors must be airtight		
<b>With the following compatible accessories:</b>		
1. Single-phase transformer compatible to the dryer and cable wires will be purchased at the local electric cooperative where the project will be established		
- Per site provision of concrete platform that can withstand the weight of transformer/s		
• 1 unit dryer: 25KVA		
• 2 units dryer: 37.5KVA		
- With protection device and able to provide sufficient continuous and peak power requirements.		
- The wire accessories and piping/conduit to connect the		

transformer up to the control panel of the drying system shall be provided by the bidder and must be brand new.		
- Maximum of 20m distance from the transformer to the service entrance.		
2. Generator set		
- Capacity: Compatible to the drying system, able to provide sufficient continuous and peak power requirements of the drying system		
- Voltage requirement compatible to the system		
- Power supply/generating system should be brand new and not refurbished.		
<ul style="list-style-type: none"> <li>• At least three years from the date of manufacture to the date of delivery to the recipient.</li> </ul>		
<ul style="list-style-type: none"> <li>• Engrave serial number</li> </ul>		
- Provided with Mechanical Transfer Switch (MTS)		
- The electrical wire, wire accessories, and piping to connect the power generating unit to the MTS and the dryer control panel/system shall be provided by the bidder		
- With thermal insulation and noise suppressor		
- Noise level: 92db maximum without an ear muff. Above 92db but not exceeding 96db provision of four (4) sets of ear muffs for operators		
- Housing design for the power generating system		
<ul style="list-style-type: none"> <li>• Dimension of the housing should be compatible to the offered power generating system</li> </ul>		
<ul style="list-style-type: none"> <li>• With a housing height of 2m (minimum) from elevated concrete floor to bottom chord</li> </ul>		
<ul style="list-style-type: none"> <li>• The housing shall be made of Corrugated G.I. roofing (0.4mm thickness, minimum), metal column, and with steel truss frame</li> </ul>		

<ul style="list-style-type: none"> <li>• Enclosed with steel matting walls</li> </ul>		
- Elevated flooring requirement		
<ul style="list-style-type: none"> <li>• With concrete elevated flooring of at least 30cm above the normal ground level and can withstand the vibration of the power generating unit (Refer to the attached layout)</li> </ul>		
- The power generating unit should have one (1) meter (minimum) distance from the perimeter wall		
- Maximum of 20m distance from the generator set and drying control unit		
3. Portable handheld moisture meter		
- Grain: Paddy, rice and other grains (optional)		
- Type: Capacitance		
- Moisture range: 12-25% or wider		
- Accuracy: $\pm 0.5\%$ or better		
- LCD/LED display		
- Battery operated		
- Automatic density and temperature compensation		
- Product brochure with technical specifications in English		
4. Standard heavy duty tools: made of tempered steel and chrome vanadium		
- One (1) set socket wrench (No. 8, 10, 11, 12, 13, 14, 15, 16, 17, 18, 19, 20, 22, 23, 24, 27, 30, 32, minimum)		
- One (1) set combination wrench (open and box, 10 pcs - size appropriate to the drying system)		
- Electrical plier: 200mm, minimum		
- Screwdriver: Philips and flat head, 300mm, minimum		
- Grease gun: 250mm cylinder length, minimum		
- Mechanical pliers: 200mm, minimum		
- Heavy duty (metal) toolbox and roll up tools holder		
<ul style="list-style-type: none"> <li>• Size that could accommodate the required tools</li> </ul>		

5. Vacuum cleaner		
- Rated input power: 1,000 W, minimum		
- Maximum air flow: 3 cubic meter/minute		
- Capacity: 30li, minimum		
- Power cord: 5m, minimum		
- Features: high capacity and high suction		
6. One (1) unit fire extinguisher		
- Dry chemical, stored pressure type, capacity: 6.80kgs, minimum		
7. Provision of disposal cart for the ashes		
8. Automatic portable bag/sack closer/sewer		
9. With complete set of Equipment Manufacturer's Manual for the drying unit, drying system, electric motor, generator set, and portable handheld moisture meter written in English/Filipino/Vernacular for each delivered unit is to be presented during the post-qualification evaluation.		
10. Copy of the brochures for the drying unit, drying system, electric motor, generator set, portable handheld moisture meter, and vacuum cleaner are to be presented during the post-qualification evaluation.		
11. Laminated reflectorized vinyl sticker RCEF Mechanization Program logo (254mm x 508mm) at the prescribed part of the dryer		
- Sticker: Weight of 140gsm and thickness of 175 microns		
- A sample picture is hereby attached		
12. Laminated reflectorized vinyl sticker RCEF Mechanization Program logo (177mm x 355mm) at the prescribed part of the power supply		
- Sticker: Weight of 140gsm and thickness of 175 microns		

- A sample picture is hereby attached		
13. Project Signage/Marker		
- Made of tubular steel: 38mm x 38mm, minimum		
- Painted on G.I. sheet #18: 1,200mm x 2,400mm, minimum		
- Refer to the attached layout, design and description		
14. Manufacturer's name plate with the serial number of the machine and the serial number of the power generating unit.		
15. Non-stainless material should be painted-finish with rust-proofing primer and final paint color.		
<b>With other technical requirements:</b>		
1. Valid AMTEC test result of a similar drying system should conform to the PNS-PAES 201:2015 standard for moisture gradient, drying rate, product quality, drying loss/spillage, drying efficiency and heating system efficiency. Separate AMTEC test report for both heating systems should be provided.		
2. With valid Permit To Operate (PTO)		
3. Testing of the dryer being offered once installed and ensures compliance to technical specifications herein		
- Random full load test of 10% per lot using fresh paddy and the other 90% will be subjected for functional test. Non-conformity with the specifications of the unit subjected to full load testing will mean full load testing of all units being supplied (samples and other expenses during full load test and functional test shall be shouldered by the bidder).		
4. Conformity as to the technical specifications of the Procuring Entity signed and sealed by an Agricultural and		



Biosystems Engineer as prescribed by the Section 27.1 of the RA 10915 otherwise known as "Philippine Agricultural and Biosystems Engineering Act of 2016", sample of which is hereto attached.		
<b>With the following Certifications:</b>		
1. Valid Certificate of Conformity (COC) to Agricultural and Fisheries Machinery or certification from BAFE of their application for COC as a condition for payment.		
2. Certification that the bidder will submit a duly signed electrical plan of the drying system offered (electrical layout, schedule of loads, general notes and/or specification, and legends/symbols) by a registered professional engineer as a condition for payment.		
3. Certification from the bidder that the offered unit is brand new, latest model, and not rebranded.		
4. National Agricultural and Fisheries Machinery Assemblers, Manufacturers, Importers, Distributors and Dealers Accreditation and Classification (NAMDAC) Certification for the Bidder.		
5. Provision of after sales services:		
- One (1) year warranty for services and parts due to manufacturing defects upon acceptance.		
- Valid Certificate of Dealership/Distributorship/Authority to sell, and Commitment to Supply directly or indirectly issued by the manufacturer or distributor to the bidder		
- Manufacturer's, distributor's or bidder's certification that the proposed grain dryer brand and generator set have been sold in the Philippine market for the last five (5) years, accompanied or duly		

supported by documentary proof. The documentary proof must be verifiable through phone call, ocular inspection or both, covering the period beginning from 2018 or earlier and maybe any or a combination of the following:		
<ul style="list-style-type: none"> <li>Record of sales</li> </ul>		
<ul style="list-style-type: none"> <li>Dealership or servicing agreements indicating the Brand subject thereof</li> </ul>		
<ul style="list-style-type: none"> <li>Bill of lading, and/or other similar records indicating shipment or delivery of the grain dryer brand to the Philippines</li> </ul>		
<ul style="list-style-type: none"> <li>Client's affidavit indicating client's complete address and telephone number, brand, type and model of grain dryer, date of purchase and duly supported by physical proof of grain dryer</li> </ul>		
<ul style="list-style-type: none"> <li>- Certification from the supplier that they will repair or replace the defective parts or components and provide after sales service within 72hours upon receipt of complaints. (PNS/BAFS/PAES 192:2016).</li> </ul>		
<ul style="list-style-type: none"> <li>- Certification of having at least two (2) technicians/personnel trained by the bidder on the operation, repair and maintenance of the heated air mechanical grain dryer.</li> </ul>		
<ul style="list-style-type: none"> <li>- Certification that the supplier will conduct training on the proper handling, operation and maintenance of the unit for at least two (2) operators per beneficiary.</li> </ul>		
6. Certification from at least 1 mechanical dryer client that they have satisfactorily complied with the provision of after sales service within 72hours upon receipt of the request.		

7. Notarized certificate of stock availability or stock allocation from the national distributor or manufacturer specifying the name of the project.		
8. Certification of guaranteed spare parts availability for at least five (5) years.		
<p>9. Certification of Very Satisfactory Performance of the Heated Air Mechanical Grain Dryer being offered as to: i) Machinery Performance; ii) Machinery Durability; and, iii) Availability of Parts and Service.</p> <p><u>Who may issue:</u></p> <ul style="list-style-type: none"> <li>- For individual customers/clients, certification from at least 3 clients is required with full address and telephone numbers.</li> <li>- Any government or private company in the Philippines, duly signed by the Current Head of Agency/Company within the last one (1) year.</li> </ul> <p><u>Excluding the following:</u></p> <ul style="list-style-type: none"> <li>- PHilMech</li> <li>- Bidder's Dealers and Authorized Service Centers</li> </ul>		

I hereby certify that the Statement of Compliance to the Foregoing Technical Specifications are true and correct, otherwise, if found false either during the bid evaluation or post-qualification, the same shall give rise to automatic disqualification of our bid.

\_\_\_\_\_  
Signature over Printed Name of Bidder

**Signed and Sealed\* by:** \_\_\_\_\_  
**Signature over Printed Name of  
Agricultural Engineer or  
Agricultural and Biosystems Engineer**

\_\_\_\_\_  
Position / Designation

\_\_\_\_\_  
(Name, Address & Tel. No. of Company)

\*as per prescribed dry seal by PRC-PRBABE Resolution No. 04 Series of 2018

<p style="text-align: center;"><b>SPECIFICATION</b></p>	<p style="text-align: center;">Statement of Compliance*</p> <p>Bidders must state here either “Comply” or “Not Comply” against each of the individual parameters of each Specification stating the corresponding performance parameter of the equipment offered. Statements of “Comply” or “Not Comply” must be supported by evidence in a Bidders Bid and cross-referenced to that evidence. Evidence shall be in the form of manufacturer’s un-amended sales literature, unconditional statements of specification and compliance issued by the manufacturer, samples, independent test data etc., as appropriate. A statement that is not supported by evidence or is subsequently found to be contradicted by the evidence presented will render the Bid under evaluation liable for rejection. A statement either in the Bidders statement of compliance or the supporting evidence that is found to be false either during Bid evaluation, post-qualification or the execution of the Contract may be regarded as fraudulent and render the Bidder or supplier liable for prosecution subject to the applicable laws and issuance.</p>	<p style="text-align: center;"><b>REFERENCE PAGE NO.</b></p>
<p><b>Supply, Delivery, Installation and Testing of Heated Air Mechanical Grain Dryer - Recirculating Batch Dryer (12 tons capacity) with Biomass and Petroleum Based Heating System</b></p>		
<p><b>Technical Specifications:</b></p>		
<p><b>Verifiable through AMTEC Test Report</b></p>		
<p>- Cracked grain, % Increase: 3%, maximum</p>		
<p>- Head rice, % decrease: 5%, maximum</p>		
<p>- Hulled/damaged grain % increase: 2%, maximum</p>		
<p>- Drying Loss/Spillage: 1%, maximum</p>		
<p>- Holding capacity: 12 tons wet palay @ 24% moisture content, minimum</p>		
<p>- Moisture gradient: 2%, maximum</p>		

- Drying efficiency: 75%, minimum		
- Drying rate: 0.8 %/hr, minimum		
<b>Verifiable during inspection</b>		
- With programmable in-line monitoring system		
• Moisture content		
• Temperature		
• Can control the heating system		
- With compatible electric motor for the drying system		
- Vertical rectangular bin		
• Consist of rectangular vertically installed drying chamber		
- With control panel		
• Mimic flow of operation		
• Basic electrical meter such as ammeter and voltmeter display		
• Basic safety cut-off features		
○ Emergency shutdown button		
○ On-off pilot lights switch button and indicating operating motor, each component with motor should have individual circuit breaker		
○ Magnetic starter with overload		
○ Interlocking system and emergency button		
- Construction: Stainless steel - SS 304 for the following parts such as:		
• Drying bin wall/cover		
• Discharge chute, 1.2mm, minimum		
• Elevator casing		
• Bottom boot section of the		

elevator		
<ul style="list-style-type: none"> <li>Drying Chamber: perforated screen for non-LSU type or inverted V-duct for LSU type</li> </ul>		
<ul style="list-style-type: none"> <li>Auger</li> </ul>		
<ul style="list-style-type: none"> <li>Auger Casing</li> </ul>		
<ul style="list-style-type: none"> <li>Receiving hopper</li> </ul>		
<ul style="list-style-type: none"> <li>Discharge pipe (supplier's standard)</li> </ul>		
<ul style="list-style-type: none"> <li>Mounting frame</li> </ul>		
<ul style="list-style-type: none"> <li>Steel angular bar (50mm x 50mm x 6mm, minimum)</li> </ul>		
<ul style="list-style-type: none"> <li>Mounting frame shall be fitted with brackets for concrete floor installation</li> </ul>		
<b>With the following components:</b>		
1. Heating system 1		
<ul style="list-style-type: none"> <li>Petroleum based fuel: Direct-fired</li> </ul>		
<ul style="list-style-type: none"> <li>Heating system efficiency: 90%, minimum (Verifiable through AMTEC Test Report)</li> </ul>		
With the following accessories:		
<ul style="list-style-type: none"> <li>Flame sensor</li> </ul>		
<ul style="list-style-type: none"> <li>Electronic ignition system</li> </ul>		
<ul style="list-style-type: none"> <li>Automatic fuel shut-off</li> </ul>		
<ul style="list-style-type: none"> <li>Adjustable fuel vaporizer</li> </ul>		
<ul style="list-style-type: none"> <li>Elevated non-corrosive and heat-resistant fuel container at 200li capacity, minimum</li> </ul>		
<ul style="list-style-type: none"> <li>Compatible electric motor for the heating system</li> </ul>		
2. Heating system 2		
<ul style="list-style-type: none"> <li>Biomass fuel: Indirect-fired</li> </ul>		
<ul style="list-style-type: none"> <li>Heating system efficiency: 50%, minimum (Verifiable through AMTEC Test Report)</li> </ul>		
<ul style="list-style-type: none"> <li>Can provide the required heating temperature or can provide 70°C drying temperature</li> </ul>		
<ul style="list-style-type: none"> <li>Heat exchanger: Stainless (SS 201, 1.2mm, minimum)/fire tubes (5mm seamless,</li> </ul>		

minimum)		
- Burning chamber: Made of refractory bricks		
• With automatic fuel feeder, Auger type		
With the following accessories:		
- With temperature control		
- With compatible electric motor		
3. Pre-cleaner		
- Input capacity: 10ton/hr, minimum		
- Sieve mechanism: All parts that come in contact with the grain must be made of stainless steel 304		
- Capable of removing large impurities and unthreshed paddy		
- With compatible electric motor		
4. With provision of ducting to divert heat source from heating system 1 or heating system 2		
- Made of stainless steel or primer painted and powdered coated B.I. or G.I. sheet		
5. Dust collection system consists of cyclone separator/collector and suction blower. All ducting shall be fabricated from sheet metal and the connectors must be airtight.		
<b>With the following compatible accessories:</b>		
1. Transformer compatible to the dryer and cable wires will be purchased at the local electric cooperative where the project will be established.		
- Per site provision of concrete platform that can withstand the weight of transformer/s		
• 1 unit dryer: 25KVA		
• 2 units dryer: 37.5KVA		
• 3 units dryer: 50KVA		

- With protection device and able to provide sufficient continuous and peak power requirements.		
- The wire accessories and piping/conduit to connect the transformer up to the control panel of the drying system shall be provided by the bidder and must be brand new.		
- Maximum of 20m distance from the transformer to the service entrance.		
2. Generator set		
- Capacity: Compatible to the drying system, able to provide sufficient continuous and peak power requirements of the drying system		
- Voltage requirement compatible to the system		
- Power supply/generating system should be brand new and not refurbished.		
<ul style="list-style-type: none"> <li>• At least three years from the date of manufacture to the date of delivery to the recipient.</li> </ul>		
<ul style="list-style-type: none"> <li>• Engrave serial number</li> </ul>		
- Provided with Mechanical Transfer Switch (MTS)		
- The electrical wire, wire accessories, and piping to connect the power generating unit to the MTS and the dryer control panel/system shall be provided by the bidder		
- With thermal insulation and noise suppressor		
- Noise level: 92db maximum without an ear muff. Above 92db but not exceeding 96db provision of four (4) sets of ear muffs for operators.		
- Housing design for the power generating system		
<ul style="list-style-type: none"> <li>• Dimension of the housing should be compatible to the offered power generating</li> </ul>		



system		
<ul style="list-style-type: none"> <li>• With a housing height of 2m (minimum) from elevated concrete floor to bottom chord</li> </ul>		
<ul style="list-style-type: none"> <li>• The housing shall be made of Corrugated G.I. roofing (0.4mm thickness, minimum), metal column, and with steel truss frame.</li> </ul>		
<ul style="list-style-type: none"> <li>• Enclosed with steel matting walls</li> </ul>		
- Elevated flooring requirement		
<ul style="list-style-type: none"> <li>• With concrete elevated flooring of at least 30cm above the normal ground level and can withstand the vibration of the power generating unit (Refer to the attached layout)</li> </ul>		
- The power generating unit should have one (1) meter (minimum) distance from the perimeter wall.		
- Maximum of 20m distance from the generator set and drying control unit		
3. Portable handheld moisture meter		
- Grain: Paddy, rice and other grains (optional)		
- Type: Capacitance		
- Moisture range: 12-25% or wider		
- Accuracy: $\pm 0.5\%$ or better		
- LCD/LED display		
- Battery operated		
- Automatic density and temperature compensation		
- Product brochure with technical specifications in English		
4. Standard heavy duty tools: made of tempered steel and chrome vanadium		
- One (1) set socket wrench (No. 8, 10, 11, 12, 13, 14, 15, 16, 17, 18, 19, 20, 22, 23, 24, 27, 30,		

32, minimum)		
- One (1) set combination wrench (open and box, 10 pcs - size appropriate to the drying system)		
- Electrical plier: 200mm, minimum		
- Screwdriver: Philips and flat head, 300mm, minimum		
- Grease gun: 250mm cylinder length, minimum		
- Mechanical pliers, 200mm, minimum		
- Heavy duty (metal) toolbox and roll up tools holder		
• Size that could accommodate the required tools		
5. Vacuum cleaner		
- Rated input power: 1,000 W, minimum		
- Maximum air flow: 3 cubic meter/minute		
- Capacity: 30li, minimum		
- Power cord: 5m, minimum		
- Features: high capacity and high suction		
6. One (1) unit fire extinguisher		
- Dry chemical, stored pressure type, capacity: 6.80kgs, minimum		
7. Provision of disposal cart for the ashes		
8. Automatic portable bag/sack closer/sewer		
9. With complete set of Equipment Manufacturer's Manual for the drying unit, drying system, electric motor, generator set, and portable handheld moisture meter written in English/Filipino/Vernacular for each delivered unit is to be presented during the post-qualification evaluation.		

10. Copy of the brochures for the drying unit, drying system, electric motor, generator set, portable handheld moisture meter, and vacuum cleaner are to be presented during the post-qualification evaluation.		
11. Laminated reflectorized vinyl sticker RCEF Mechanization Program logo (254mm x 508mm) at the prescribed part of the dryer.		
- Sticker: Weight of 140gsm and thickness of 175 microns		
- A sample picture is hereby attached		
12. Laminated reflectorized vinyl sticker RCEF Mechanization Program logo (177mm x 355mm) at the prescribed part of the power supply.		
- Sticker: Weight of 140gsm and thickness of 175 microns		
- A sample picture is hereby attached		
13. Project Signage/Marker		
- Made of tubular steel: 38mm x 38mm, minimum		
- Painted on G.I. sheet #18: 1,200mm x 2,400mm, minimum		
- Refer to the attached layout, design and description		
14. Manufacturer's name plate with the serial number of the machine and the serial number of the power generating unit.		
15. Non-stainless material should be painted-finish with rust-proofing primer and final paint color.		
<b>With other technical requirements:</b>		
1. Valid AMTEC test result of a similar drying system should conform to the PNS-PAES 201:2015 standard for moisture gradient, drying rate,		

product quality, drying loss/spillage, drying efficiency and heating system efficiency. Separate AMTEC test report for both heating systems should be provided.		
2. With valid Permit To Operate (PTO)		
3. Testing of the dryer being offered once installed and ensures compliance to technical specifications herein		
- Random full load test of 10% per lot using fresh paddy and the other 90% will be subjected for functional test. Non-conformity with the specifications of the unit subjected to full load testing will mean full load testing of all units being supplied (samples and other expenses during full load test and functional test shall be shouldered by the bidder).		
4. Conformity as to the technical specifications of the Procuring Entity signed and sealed by an Agricultural and Biosystems Engineer as prescribed by the Section 27.1 of the RA 10915 otherwise known as "Philippine Agricultural and Biosystems Engineering Act of 2016", sample of which is hereto attached.		
<b>With the following Certifications:</b>		
1. Valid Certificate of Conformity (COC) to Agricultural and Fisheries Machinery or certification from BAFE of their application for COC as a condition for payment.		
2. Certification that the bidder will submit a duly signed electrical plan of the drying system offered (electrical layout, schedule of loads, general notes and/or specification, and		

legends/symbols) by a registered professional engineer as a condition for payment.		
3. Certification from the bidder that the offered unit is brand new, latest model, and not rebranded.		
4. National Agricultural and Fisheries Machinery Assemblers, Manufacturers, Importers, Distributors and Dealers Accreditation and Classification (NAMDAC) Certification for the Bidder.		
5. Provision of after sales services:		
- One (1) year warranty for services and parts due to manufacturing defects upon acceptance.		
- Valid Certificate of Dealership/Distributorship/Authority to sell, and Commitment to Supply directly or indirectly issued by the manufacturer or distributor to the bidder.		
- Manufacturer's, distributor's or bidder's certification that the proposed grain dryer brand and generator set have been sold in the Philippine market for the last five (5) years, accompanied or duly supported by documentary proof. The documentary proof must be verifiable through phone call, ocular inspection or both, covering the period beginning from 2018 or earlier and maybe any or a combination of the following:		
• Record of sales		
• Dealership or servicing agreements indicating the Brand subject thereof		
• Bill of lading, and/or other similar records indicating		

shipment or delivery of the grain dryer brand to the Philippines		
<ul style="list-style-type: none"> <li>• Client's affidavit indicating client's complete address and telephone number, brand, type and model of grain dryer, date of purchase and duly supported by physical proof of grain dryer</li> </ul>		
<ul style="list-style-type: none"> <li>- Certification from the supplier that they will repair or replace the defective parts or components and provide after sales service within 72hours upon receipt of complaints. (PNS/BAFS/PAES 192:2016).</li> </ul>		
<ul style="list-style-type: none"> <li>- Certification of having at least two (2) technicians/personnel trained by the bidder on the operation, repair and maintenance of the heated air mechanical grain dryer.</li> </ul>		
<ul style="list-style-type: none"> <li>- Certification that the supplier will conduct training on the proper handling, operation and maintenance of the unit for at least two (2) operators per beneficiary.</li> </ul>		
6. Certification from at least 1 mechanical dryer client that they have satisfactorily complied with the provision of after sales service within 72hours upon receipt of the request.		
7. Notarized certificate of stock availability or stock allocation from the national distributor or manufacturer specifying the name of the project		
8. Certification of guaranteed spare parts availability for at least five (5) years		

<p>9. Certification of Very Satisfactory Performance of the Heated Air Mechanical Grain Dryer being offered as to: i) Machinery Performance; ii) Machinery Durability; and, iii) Availability of Parts and Service.</p> <p><u>Who may issue:</u></p> <ul style="list-style-type: none"> <li>- For individual customers/clients, certification from at least 3 clients is required with full address and telephone numbers.</li> <li>- Any government or private company in the Philippines, duly signed by the Current Head of Agency/Company within the last one (1) year.</li> </ul> <p><u>Excluding the following:</u></p> <ul style="list-style-type: none"> <li>- PHilMech</li> <li>- Bidder's Dealers and Authorized Service Centers</li> </ul>		
---	--	--

I hereby certify that the Statement of Compliance to the Foregoing Technical Specifications are true and correct, otherwise, if found false either during the bid evaluation or post-qualification, the same shall give rise to automatic disqualification of our bid.

\_\_\_\_\_  
Signature over Printed Name of Bidder

**Signed and Sealed\* by:** \_\_\_\_\_  
**Signature over Printed Name of**  
**Agricultural Engineer or**  
**Agricultural and Biosystems Engineer**

\_\_\_\_\_  
Position / Designation

\_\_\_\_\_  
(Name, Address & Tel. No. of Company)

\*as per prescribed dry seal by PRC-PRBABA Resolution No. 04 Series of 2018

**PROJECT SIGNAGE/MARKER LAYOUT DESIGN  
(FOR POSTHARVEST TECHNOLOGIES)**

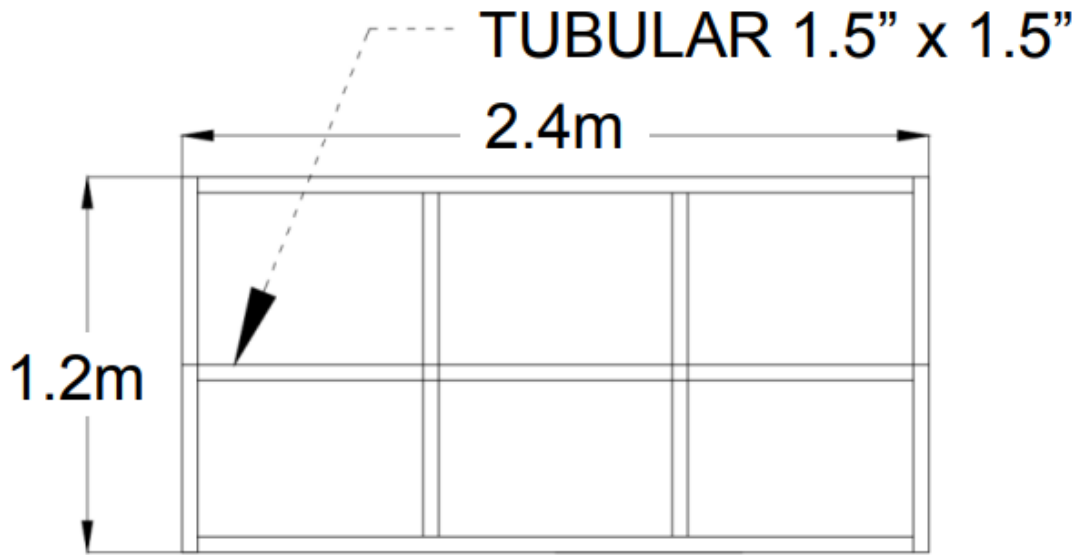

**FRAMING PLAN**



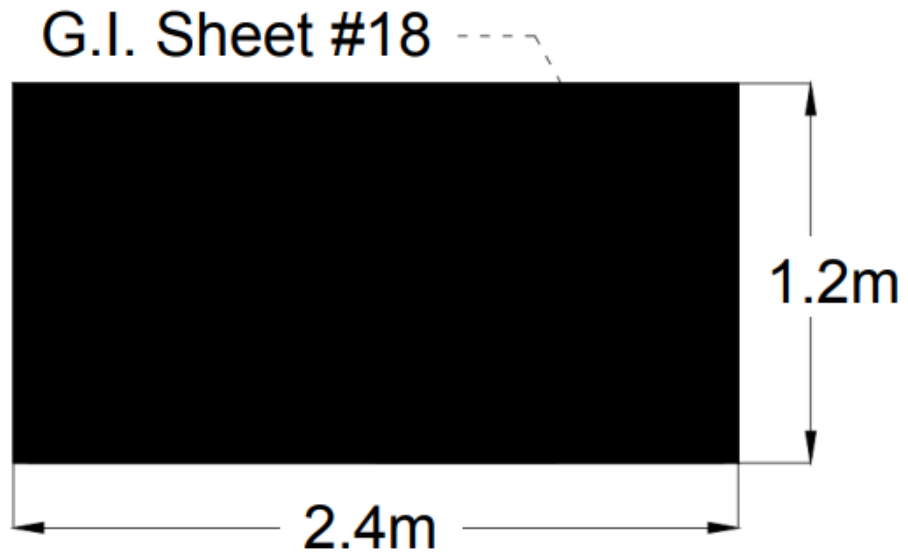

## **FRONT VIEW W/ G.I Sheet**

# G.I. Sheet #18

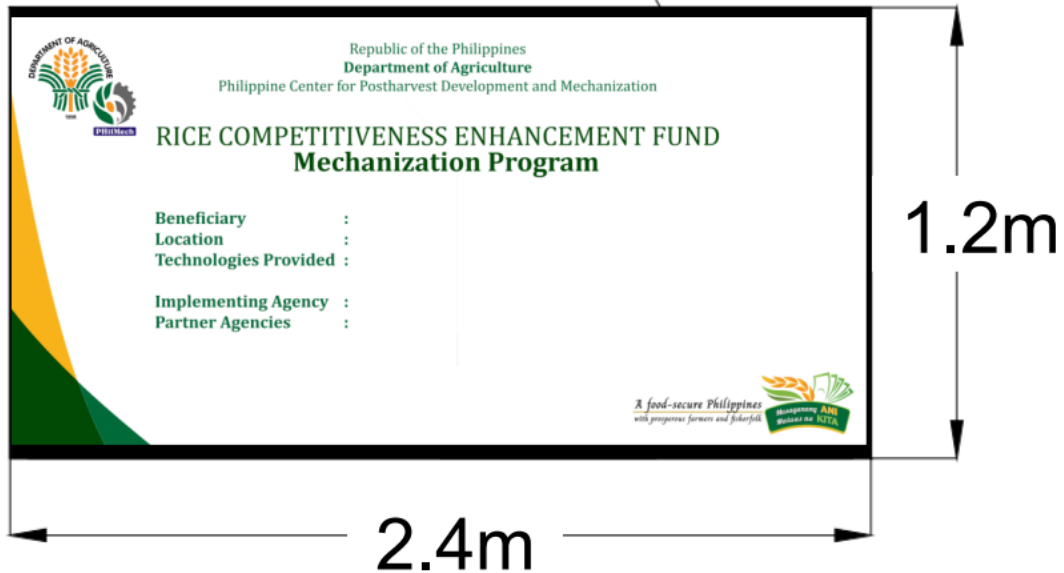

## PAINTED ON G.I Sheet

**Laminated reflectorized vinyl sticker Sample**



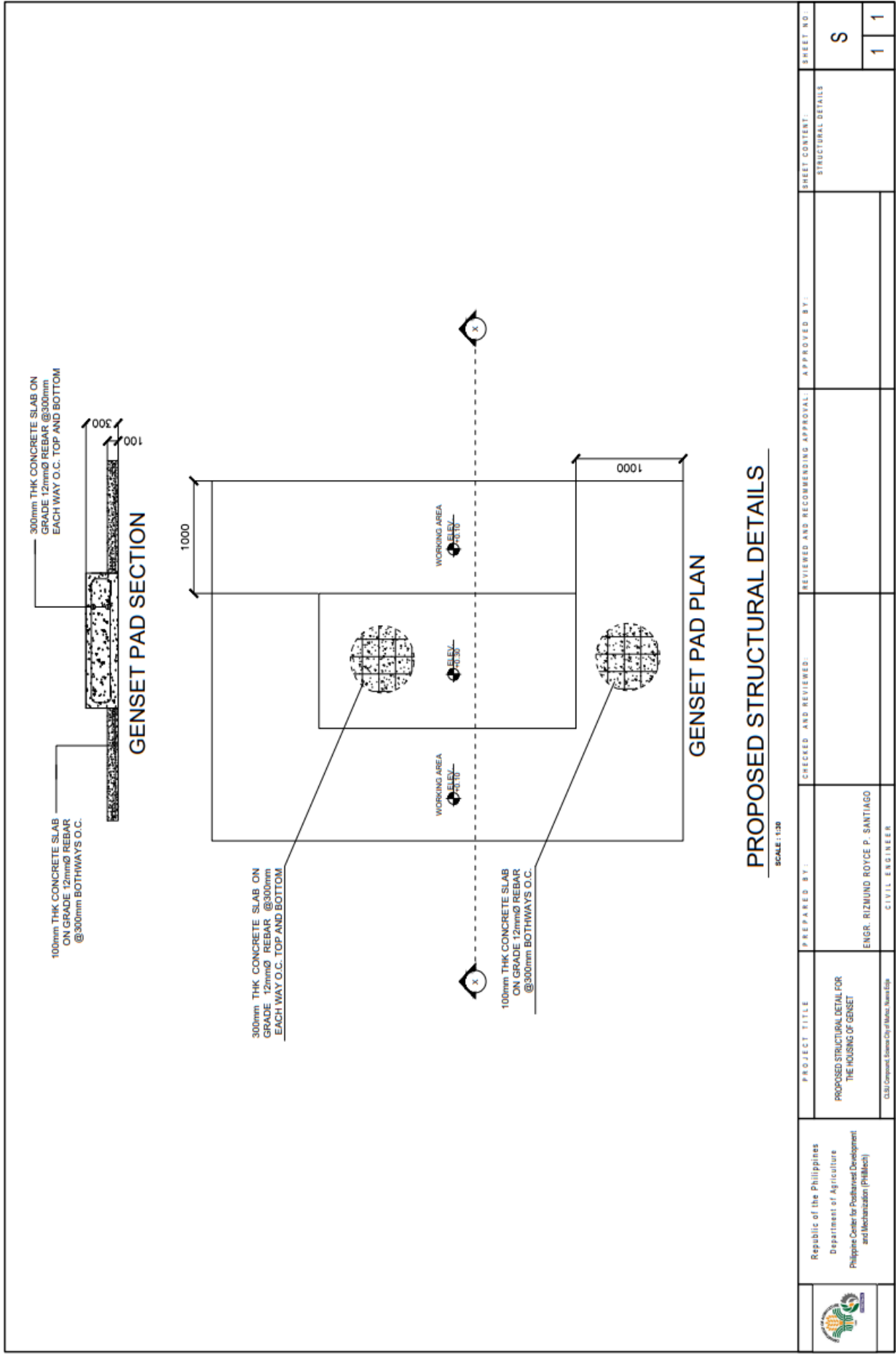

	Republic of the Philippines Department of Agriculture Philippine Center for Postharvest Development and Mechanization (PhilMech)	PROJECT TITLE	PREPARED BY:	CHECKED AND REVIEWED:	REVIEWED AND RECOMMENDING APPROVAL:	SHEET CONTENT:	SHEET NO.
		PROPOSED STRUCTURAL DETAIL FOR THE HOUSING OF GENSET <small>C-33 Compound, Sisonog City of Marikina City</small>	ENGR. RIZMUND ROYCE P. SANTIAGO <small>CIVIL ENGINEER</small>				STRUCTURAL DETAILS S 1   1

**SAMPLE OF AGRICULTURAL AND BIOSYSTEMS ENGINEER SEAL AS PRESCRIBED BY THE SECTION 27.1 OF THE RA 10915**

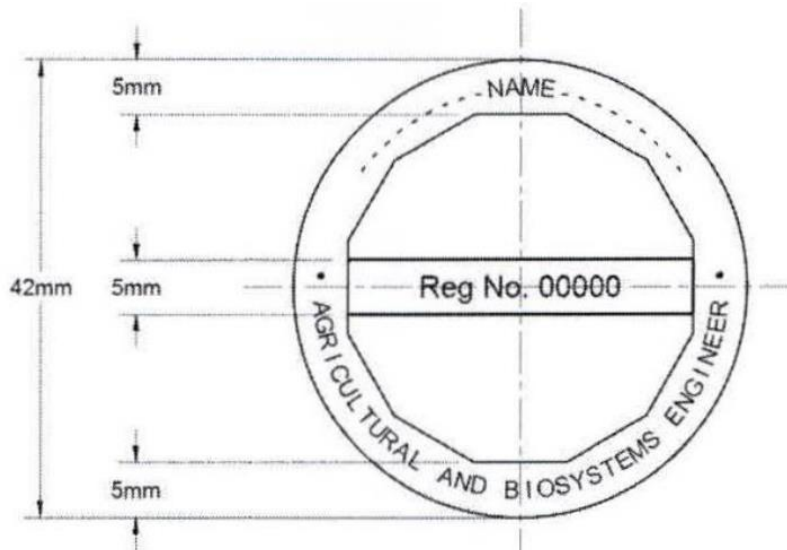

*Seal of Agricultural and Biosystems Engineer*



Republic of the Philippines  
Department of Agriculture

Philippine Center for Postharvest  
Development and Mechanization (PHilMech)  
SCIENCE CITY OF MUÑOZ, NUEVA ECIJA

## PROPOSED STRUCTURAL DETAIL FOR THE HOUSING OF GENSET

“Read and accepted as part of the contract”

\_\_\_\_\_  
61  
BIDDER'S SIGNATURE

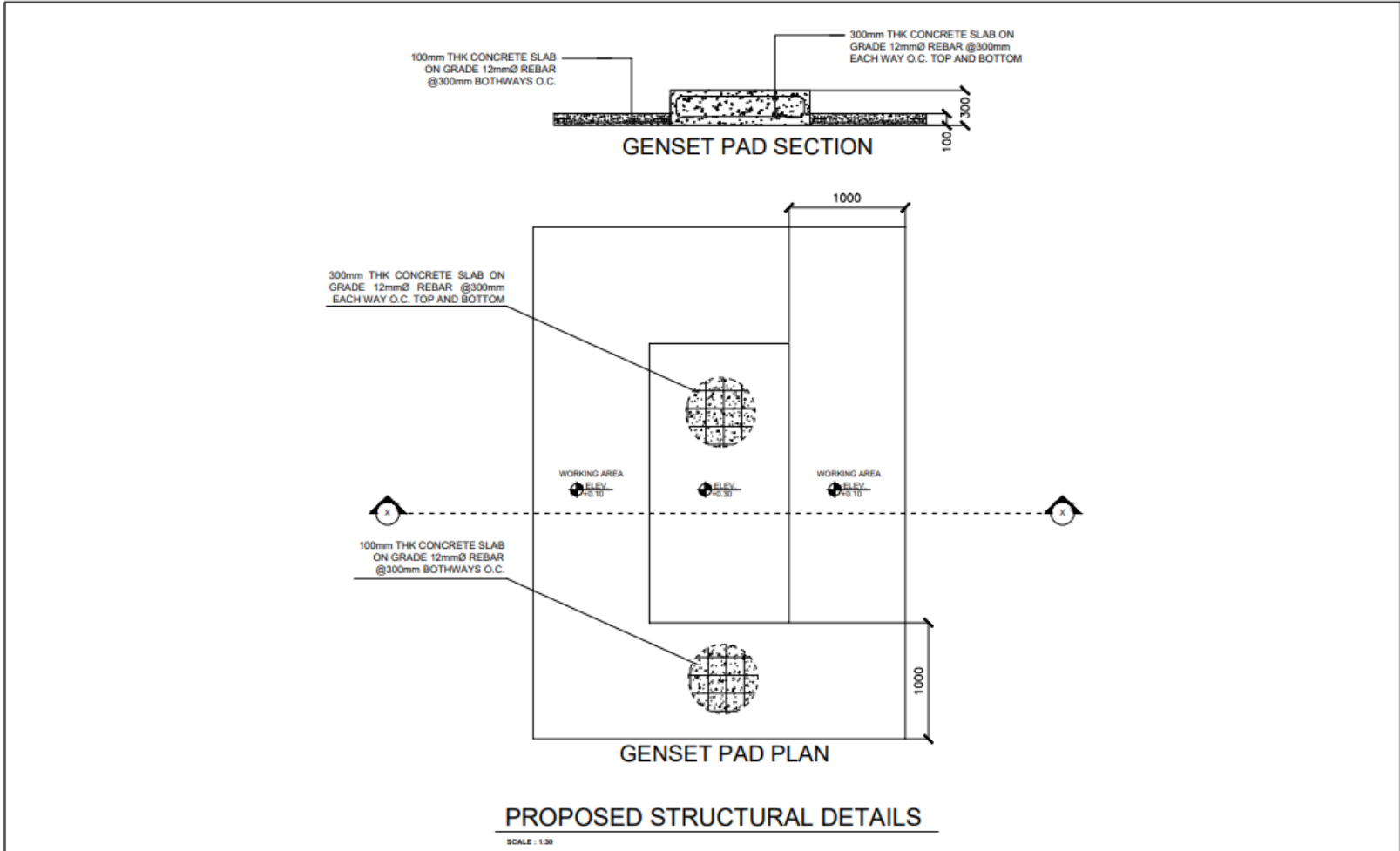

	Republic of the Philippines Department of Agriculture Philippine Center for Postharvest Development and Mechanization (PHIMech)	PROJECT TITLE	PREPARED BY:	CHECKED AND REVIEWED:	REVIEWED AND RECOMMENDING APPROVAL:	APPROVED BY:	SHEET CONTENT:	SHEET NO.:
	PROPOSED STRUCTURAL DETAIL FOR THE HOUSING OF GENSET	ENGR. RIZMUND ROYCE P. SANTIAGO	CIVIL ENGINEER				STRUCTURAL DETAILS	S
	1	1						

“Read and accepted as part of the contract”

62  
BIDDER'S SIGNATURE

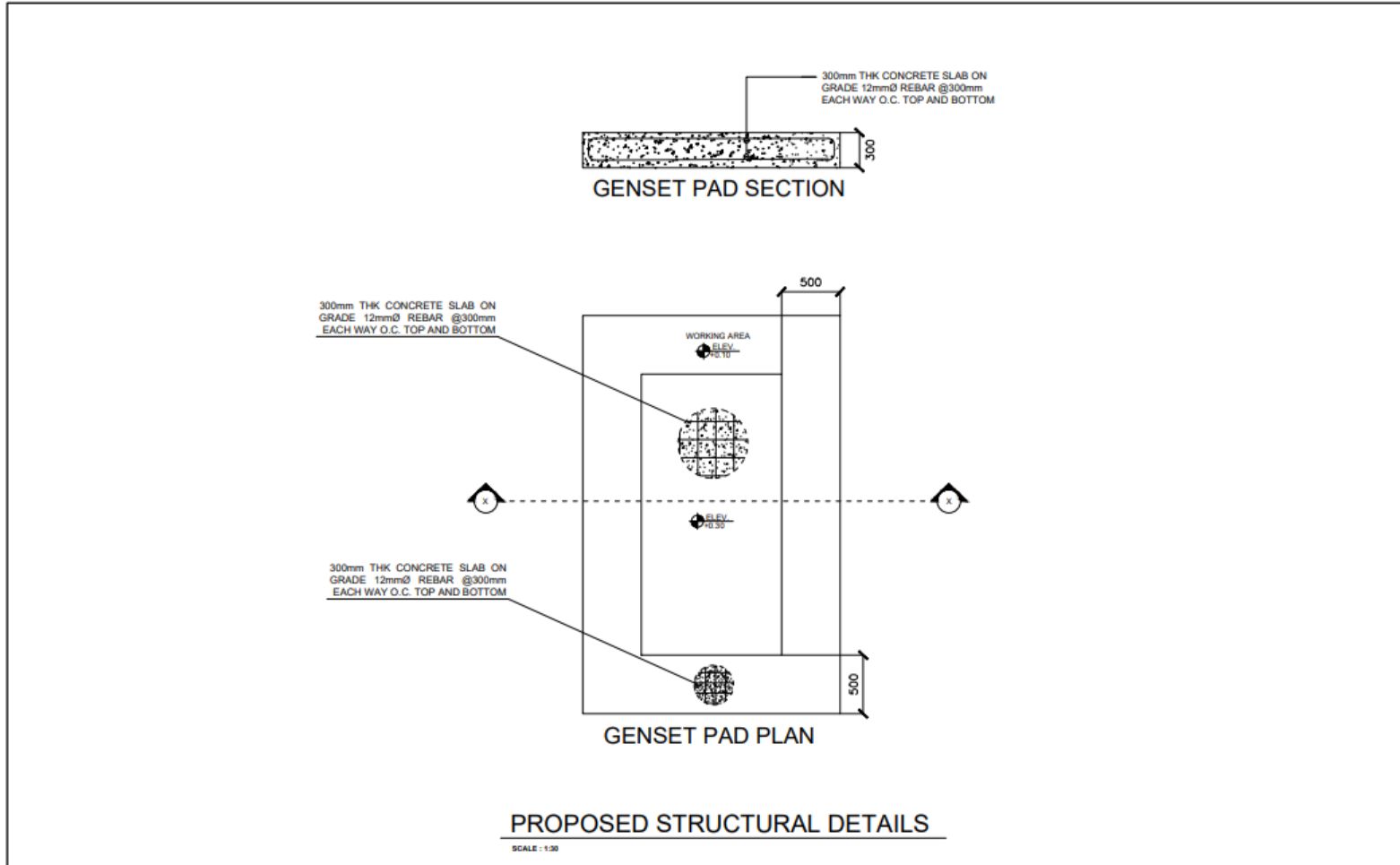

	Republic of the Philippines Department of Agriculture Philippine Center for Postharvest Development and Mechanization (PHIMech)	PROJECT TITLE	PREPARED BY:	CHECKED AND REVIEWED:	REVIEWED AND RECOMMENDING APPROVAL:	APPROVED BY:	SHEET CONTENT:	SHEET NO.
	PROPOSED STRUCTURAL DETAIL FOR THE HOUSING OF ONE GENSET	ENGR. RIZMUND ROYCE P. SANTIAGO CIVIL ENGINEER					STRUCTURAL DETAILS	S
	<small>03/50 Compound, Science City of Muñoz, Nueva Ecija</small>	<small>CIVIL ENGINEER</small>						1 1

“Read and accepted as part of the contract”

63  
BIDDER'S SIGNATURE



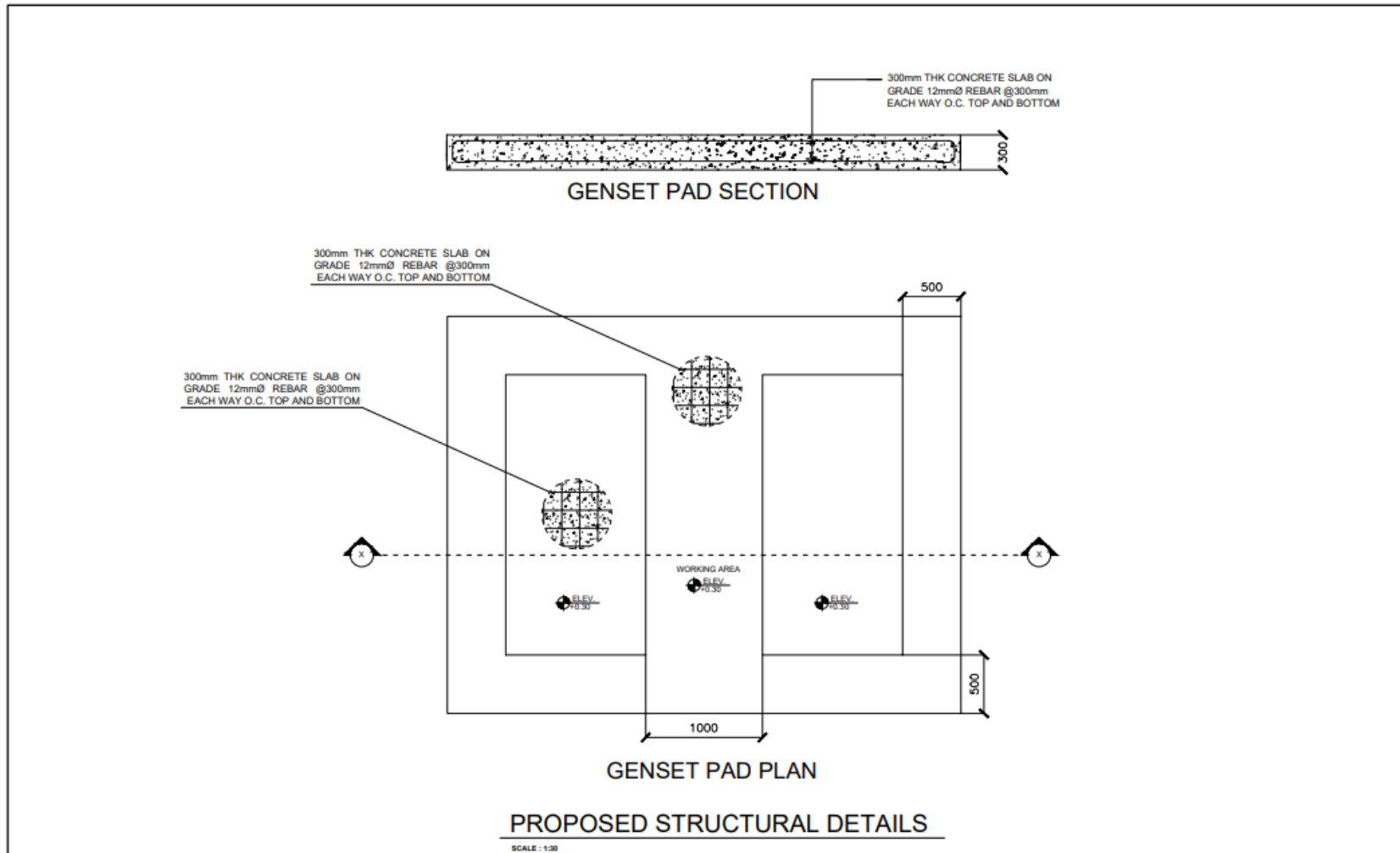

	Republic of the Philippines Department of Agriculture Philippine Center for Postharvest Development and Mechanization (PHMech)	PROJECT TITLE	PREPARED BY	CHECKED AND REVIEWED	REVIEWED AND RECOMMENDING APPROVAL	APPROVED BY	SHEET CONTENT	SHEET NO.	
		PROPOSED STRUCTURAL DETAIL FOR THE HOUSING OF TWO GENSET	ENGR. RIZMUND ROYCE P. SANTIAGO					STRUCTURAL DETAILS	S
		<small>CLSU Compound, Science City of Muñoz, Nueva Ecija</small>	<small>CIVIL ENGINEER</small>						1   1

“Read and accepted as part of the contract”

64  
BIDDER'S SIGNATURE

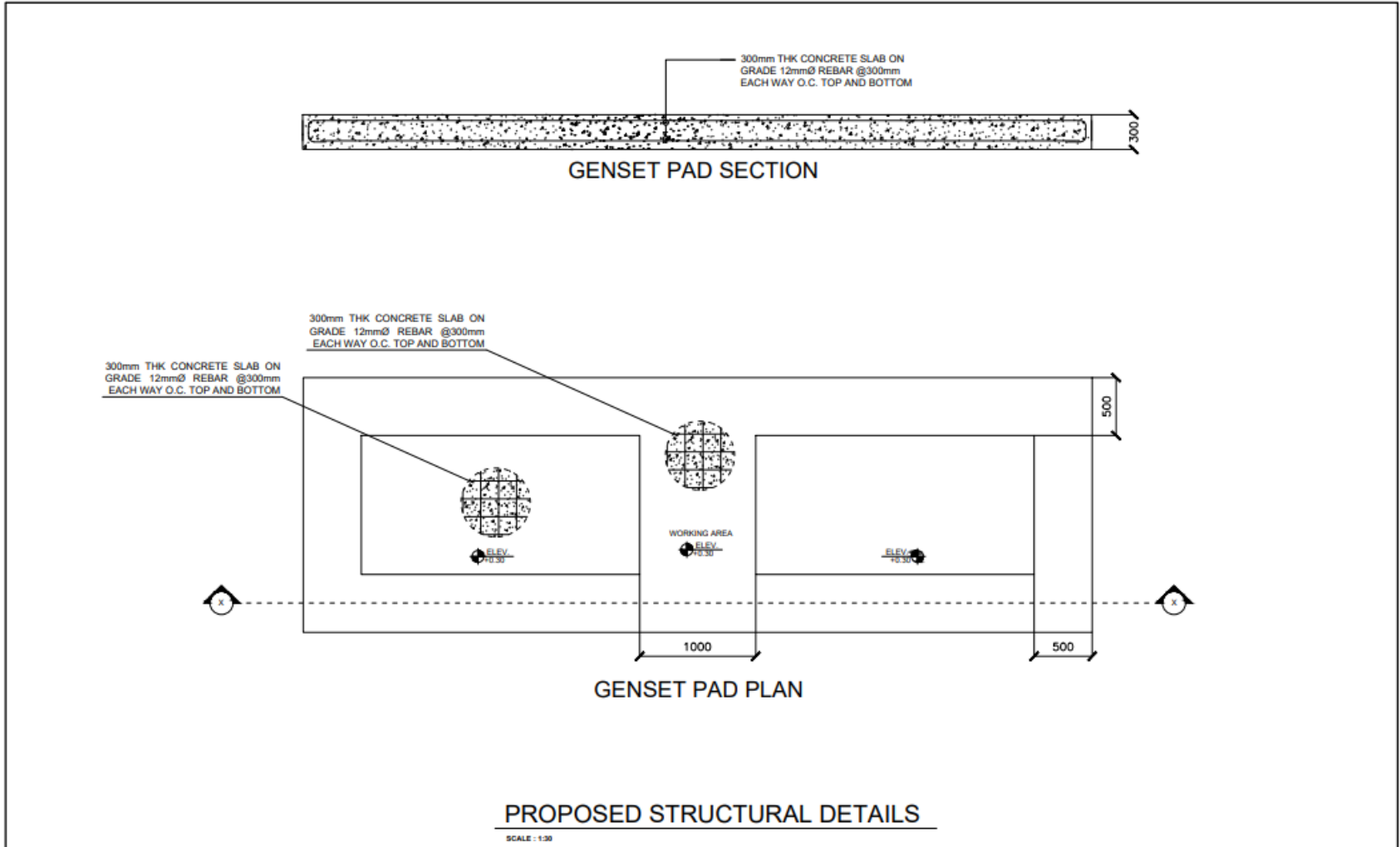

	Republic of the Philippines Department of Agriculture Philippine Center for Postharvest Development and Mechanization (PHIMech)	PROJECT TITLE	PREPARED BY:	CHECKED AND REVIEWED:	REVIEWED AND RECOMMENDING APPROVAL:	APPROVED BY:	SHEET CONTENT:	SHEET NO.:
	PROPOSED STRUCTURAL DETAIL FOR THE HOUSING OF TWO GENSET	ENGR. RIZMUND ROYCE P. SANTIAGO CIVIL ENGINEER					STRUCTURAL DETAILS	S
	<small>0.50 Compound, Science City of Muñoz, Nueva Ecija</small>							1   1

“Read and accepted as part of the contract”

65  
BIDDER'S SIGNATURE

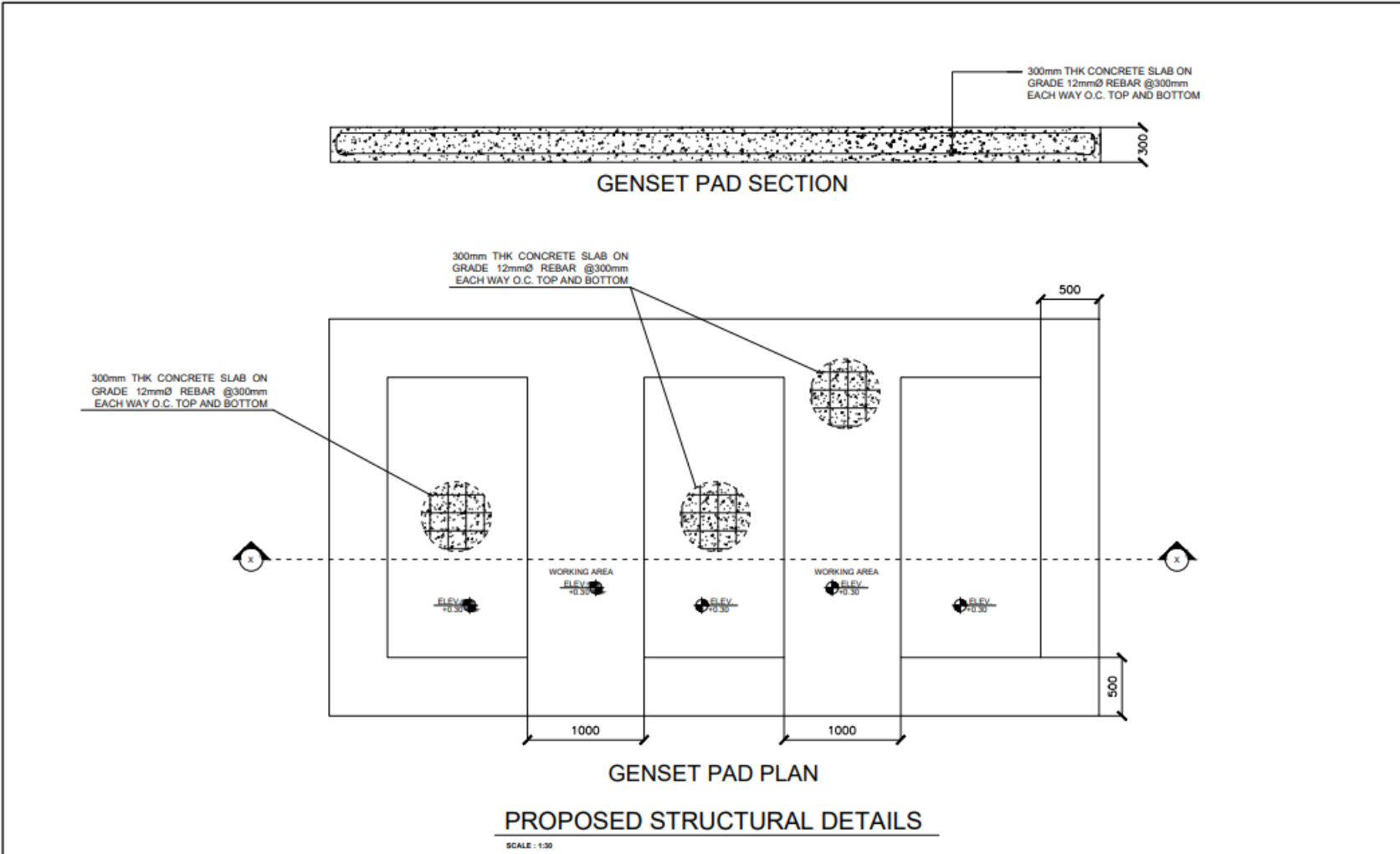

	Republic of the Philippines Department of Agriculture Philippine Center for Postharvest Development and Mechanization (PHIMech)	PROJECT TITLE	PREPARED BY:	CHECKED AND REVIEWED:	REVIEWED AND RECOMMENDING APPROVAL:	APPROVED BY:	SHEET CONTENT:	SHEET NO:	
		PROPOSED STRUCTURAL DETAIL FOR THE HOUSING OF THREE GENSET	ENGR. RIZMUND ROYCE P. SANTIAGO					STRUCTURAL DETAILS	S
		0.50 Compound, Science City of Muñoz, Nueva Ecija	CIVIL ENGINEER						1   1

“Read and accepted as part of the contract”

66  
BIDDER'S SIGNATURE

# ***Section VIII. Checklist of Technical and Financial Documents***

# Checklist of Technical and Financial Documents

## I. TECHNICAL COMPONENT ENVELOPE

### Class “A” Documents

#### Legal Documents

- (a) Valid PhilGEPS Registration Certificate (Platinum Membership) (all pages) **in accordance with Section 8.5.2 of the IRR;**

#### Technical Documents

- (b) Statement of the prospective bidder of all its ongoing government and private contracts, including contracts awarded but not yet started **and/or delivered but not yet inspected and accepted**, if any, whether similar or not similar in nature and complexity to the contract to be bid; **and**
- (c) Statement of the bidder’s Single Largest Completed Contract (SLCC) similar to the contract to be bid, except under conditions provided for in Sections 23.4.1.3 and 23.4.2.4 of the 2016 revised IRR of RA No. 9184, within the relevant period as provided in the Bidding Documents; **and**
- (d) Original copy of Bid Security. If in the form of a Surety Bond, submit also a certification issued by the Insurance Commission;  
**or**  
Original copy of Notarized Bid Securing Declaration; **and**
- (e) Conformity with the Technical Specifications, which may include production/delivery schedule, manpower requirements, and/or after-sales/parts, if applicable; **and**
- (f) Schedule of Requirements; **and**
- (g) Original duly signed Omnibus Sworn Statement (OSS);
- (h) **and** if applicable, Original Notarized Secretary’s Certificate in case of a corporation, partnership, or cooperative; or Original Special Power of Attorney of all members of the joint venture giving full power and authority to its officer to sign the OSS and do acts to represent the Bidder.

#### Financial Documents

- (i) The prospective bidder’s computation of Net Financial Contracting Capacity (NFCC);  
**or**  
A committed Line of Credit from a Universal or Commercial Bank in lieu of its NFCC computation.

#### *Class “B” Documents*

- (j) If applicable, a duly signed joint venture agreement (JVA) in case the joint venture is already in existence;  
**or**  
duly notarized statements from all the potential joint venture partners stating that they will enter into and abide by the provisions of the JVA in the instance that the bid is successful.

#### Other documentary requirements under RA No. 9184 (as applicable)

- (k) *[For foreign bidders claiming by reason of their country’s extension of reciprocal rights to Filipinos]* Certification from the relevant government

office of their country stating that Filipinos are allowed to participate in government procurement activities for the same item or product.

- (l) Certification from the DTI if the Bidder claims preference as a Domestic Bidder or Domestic Entity.

## **II. FINANCIAL COMPONENT ENVELOPE**

- (a) Original of duly signed and accomplished Financial Bid Form; **and**
- (b) Original of duly signed and accomplished Price Schedule(s).

**Bid Form for the Procurement of Goods**  
*[shall be submitted with the Bid]*

---

**Bid Form (Lot No.)**

Date : \_\_\_\_\_  
Project Identification No. : \_\_\_\_\_

To: *[name and address of Procuring Entity]*

Having examined the Philippine Bidding Documents (PBDs) including the Supplemental or Bid Bulletin Numbers *[insert numbers]*, the receipt of which is hereby duly acknowledged, we, the undersigned, offer to *[supply/deliver/perform]* *[description of the Goods]* in conformity with the said PBDs for the sum of *[total Bid amount in words and figures]* or the total calculated bid price, as evaluated and corrected for computational errors, and other bid modifications in accordance with the Price Schedules attached herewith and made part of this Bid. The total bid price includes the cost of all taxes, such as, but not limited to: *[specify the applicable taxes, e.g. (i) value added tax (VAT), (ii) income tax, (iii) local taxes, and (iv) other fiscal levies and duties]*, which are itemized herein or in the Price Schedules,

If our Bid is accepted, we undertake:

- a. to deliver the goods in accordance with the delivery schedule specified in the Schedule of Requirements of the Philippine Bidding Documents (PBDs);
- b. to provide a performance security in the form, amounts, and within the times prescribed in the PBDs;
- c. to abide by the Bid Validity Period specified in the PBDs and it shall remain binding upon us at any time before the expiration of that period.

*[Insert this paragraph if Foreign-Assisted Project with the Development Partner:*

Commissions or gratuities, if any, paid or to be paid by us to agents relating to this Bid, and to contract execution if we are awarded the contract, are listed below:

Name and address of agent	Amount and Purpose of Commission or gratuity
---------------------------	--

_____	_____
_____	_____
_____	_____

(if none, state "None") ]

Until a formal Contract is prepared and executed, this Bid, together with your written acceptance thereof and your Notice of Award, shall be binding upon us.

We understand that you are not bound to accept the Lowest Calculated Bid or any Bid you may receive.

We certify/confirm that we comply with the eligibility requirements pursuant to the PBDs.

The undersigned is authorized to submit the bid on behalf of *[name of the bidder]* as evidenced by the attached *[state the written authority]*.

We acknowledge that failure to sign each and every page of this Bid Form, including the attached Schedule of Prices, shall be a ground for the rejection of our bid.

Name: \_\_\_\_\_

Legal capacity: \_\_\_\_\_

Signature: \_\_\_\_\_

Duly authorized to sign the Bid for and behalf of: \_\_\_\_\_

Date: \_\_\_\_\_



**Price Schedule for Goods Offered from Abroad**  
*[shall be submitted with the Bid if bidder is offering goods from Abroad]*

---

*For Goods Offered from Abroad*

Name of Bidder \_\_\_\_\_ Project ID No. \_\_\_\_\_ Page \_\_\_\_ of \_\_\_\_

1	2	3	4	5	6	7	8	9
Item	Description	Country of origin	Quantity	Unit price CIF port of entry (specify port) or CIP named place  (specify border point or place of destination)	Total CIF or CIP price per item  (col. 4 x 5)	Unit Price Delivered Duty Unpaid (DDU)	Unit price Delivered Duty Paid (DDP)	Total Price delivered DDP (col 4 x 8)

Name: \_\_\_\_\_

Legal Capacity: \_\_\_\_\_

Signature: \_\_\_\_\_

Duly authorized to sign the Bid for and behalf of: \_\_\_\_\_

**Price Schedule for Goods Offered from Within the Philippines**  
*[shall be submitted with the Bid if bidder is offering goods from within the Philippines]*

**For Goods Offered from Within the Philippines**

Name of Bidder \_\_\_\_\_ Project ID No. \_\_\_\_\_ Page \_\_\_ of \_\_\_

1	2	3	4	5	6	7	8	9	10
Item	Description	Country of origin	Quantity	Unit price EXW per item	Transportation and all other costs incidental to delivery, per item	Sales and other taxes payable if Contract is awarded, per item	Cost of Incidental Services, if applicable, per item	Total Price, per unit (col 5+6+7+8)	Total Price delivered Final Destination (col 9) x (col 4)

Name: \_\_\_\_\_

Legal Capacity: \_\_\_\_\_

Signature: \_\_\_\_\_

Duly authorized to sign the Bid for and behalf of: \_\_\_\_\_

## Contract Agreement Form

---

THIS AGREEMENT made the \_\_\_\_ day of \_\_\_\_\_ 20\_\_\_\_ between [name of PROCURING ENTITY] of the Philippines (hereinafter called “the Entity”) of the one part and [name of Supplier] of [city and country of Supplier] (hereinafter called “the Supplier”) of the other part;

WHEREAS, the Entity invited Bids for certain goods and ancillary services, particularly [brief description of goods and services] and has accepted a Bid by the Supplier for the supply of those goods and services in the sum of [*contract price in words and figures in specified currency*] (hereinafter called “the Contract Price”).

NOW THIS AGREEMENT WITNESSETH AS FOLLOWS:

1. In this Agreement words and expressions shall have the same meanings as are respectively assigned to them in the Conditions of Contract referred to.
2. The following documents as required by the 2016 revised Implementing Rules and Regulations of Republic Act No. 9184 shall be deemed to form and be read and construed as integral part of this Agreement, *viz.*:
  - i. Philippine Bidding Documents (PBDs);
    - i. Schedule of Requirements;
    - ii. Technical Specifications;
    - iii. General and Special Conditions of Contract; and
    - iv. Supplemental or Bid Bulletins, if any
  - ii. Winning bidder’s bid, including the Eligibility requirements, Technical and Financial Proposals, and all other documents or statements submitted;  
  
Bid form, including all the documents/statements contained in the Bidder’s bidding envelopes, as annexes, and all other documents submitted (*e.g.*, Bidder’s response to request for clarifications on the bid), including corrections to the bid, if any, resulting from the Procuring Entity’s bid evaluation;
  - iii. Performance Security;
  - iv. Notice of Award of Contract; and the Bidder’s conforme thereto; and
  - v. Other contract documents that may be required by existing laws and/or the Procuring Entity concerned in the PBDs. **Winning bidder agrees that additional contract documents or information prescribed by the GPPB that are subsequently required for submission after the contract execution, such as the Notice to Proceed, Variation Orders, and Warranty Security, shall likewise form part of the Contract.**

3. In consideration for the sum of *[total contract price in words and figures]* or such other sums as may be ascertained, *[Named of the bidder]* agrees to *[state the object of the contract]* in accordance with his/her/its Bid.
4. The *[Name of the procuring entity]* agrees to pay the above-mentioned sum in accordance with the terms of the Bidding.

IN WITNESS whereof the parties hereto have caused this Agreement to be executed in accordance with the laws of the Republic of the Philippines on the day and year first above written.

*[Insert Name and Signature]*

*[Insert Name and Signature]*

*[Insert Signatory's Legal Capacity]*

*[Insert Signatory's Legal Capacity]*

*for:*

*for:*

*[Insert Procuring Entity]*

*[Insert Name of Supplier]*

**Acknowledgment**

*[Format shall be based on the latest Rules on Notarial Practice]*

**SUPPLY, DELIVERY, INSTALLATION AND TESTING OF VARIOUS HEATED  
AIR MECHANICAL GRAIN DRYERS**  
*[PHilMech RCEF-23-11-31]*

<p style="text-align: center;"><b>Lot no/s. being bid:</b></p> <hr style="width: 80%; margin: 10px auto;"/>	<p style="text-align: center;"><b>Name and Signature of Authorized Representative:</b></p> <hr style="width: 80%; margin: 10px auto;"/>
---	---

**Omnibus Sworn Statement**

REPUBLIC OF THE PHILIPPINES )  
CITY/MUNICIPALITY OF \_\_\_\_\_ ) S.S.

**AFFIDAVIT**

I, [Name of Affiant], of legal age, [Civil Status], [Nationality], and residing at [Address of Affiant], after having been duly sworn in accordance with law, do hereby depose and state that:

1. *[Select one, delete the other:]*

*[If a sole proprietorship:]* I am the sole proprietor or authorized representative of [Name of Bidder] with office address at [address of Bidder];

*[If a partnership, corporation, cooperative, or joint venture:]* I am the duly authorized and designated representative of [Name of Bidder] with office address at [address of Bidder];

2. *[Select one, delete the other:]*

*[If a sole proprietorship:]* As the owner and sole proprietor, or authorized representative of [Name of Bidder], I have full power and authority to do, execute and perform any and all acts necessary to participate, submit the bid, and to sign and execute the ensuing contract for [Name of the Project] of the [Name of the Procuring Entity], as shown in the attached duly notarized Special Power of Attorney;

*[If a partnership, corporation, cooperative, or joint venture:]* I am granted full power and authority to do, execute and perform any and all acts necessary to participate, submit the bid, and to sign and execute the ensuing contract for [Name of the Project] of the [Name of the Procuring Entity], as shown in the attached [state title of attached document showing proof of authorization (e.g., duly notarized Secretary’s Certificate, Board/Partnership Resolution, or Special Power of Attorney, whichever is applicable)];

3. [Name of Bidder] is not “blacklisted” or barred from bidding by the Government of the Philippines or any of its agencies, offices, corporations, or Local Government Units,

foreign government/foreign or international financing institution whose blacklisting rules have been recognized by the Government Procurement Policy Board, **by itself or by relation, membership, association, affiliation, or controlling interest with another blacklisted person or entity as defined and provided for in the Uniform Guidelines on Blacklisting;**

4. Each of the documents submitted in satisfaction of the bidding requirements is an authentic copy of the original, complete, and all statements and information provided therein are true and correct;
5. [Name of Bidder] is authorizing the Head of the Procuring Entity or its duly authorized representative(s) to verify all the documents submitted;
6. *[Select one, delete the rest:]*

*[If a sole proprietorship:]* The owner or sole proprietor is not related to the Head of the Procuring Entity, members of the Bids and Awards Committee (BAC), the Technical Working Group, and the BAC Secretariat, the head of the Project Management Office or the end-user unit, and the project consultants by consanguinity or affinity up to the third civil degree;

*[If a partnership or cooperative:]* None of the officers and members of *[Name of Bidder]* is related to the Head of the Procuring Entity, members of the Bids and Awards Committee (BAC), the Technical Working Group, and the BAC Secretariat, the head of the Project Management Office or the end-user unit, and the project consultants by consanguinity or affinity up to the third civil degree;

*[If a corporation or joint venture:]* None of the officers, directors, and controlling stockholders of *[Name of Bidder]* is related to the Head of the Procuring Entity, members of the Bids and Awards Committee (BAC), the Technical Working Group, and the BAC Secretariat, the head of the Project Management Office or the end-user unit, and the project consultants by consanguinity or affinity up to the third civil degree;

7. *[Name of Bidder]* complies with existing labor laws and standards; and
8. *[Name of Bidder]* is aware of and has undertaken the responsibilities as a Bidder in compliance with the Philippine Bidding Documents, which includes:
  - a. Carefully examining all of the Bidding Documents;
  - b. Acknowledging all conditions, local or otherwise, affecting the implementation of the Contract;
  - c. Making an estimate of the facilities available and needed for the contract to be bid, if any;
  - d. Inquiring or securing Supplemental/Bid Bulletin(s) issued for the *[Name of the Project]*; and
  - e. Monitoring of electronic service of related notices at *[insert bidder's email address]*. Bidder hereby acknowledges that service of notice to the email address indicated above shall be tantamount to actual service of such notice and shall be deemed received by the bidder on the date of service or email.

9. *[Name of Bidder]* did not give or pay directly or indirectly, any commission, amount, fee, or any form of consideration, pecuniary or otherwise, to any person or official, personnel or representative of the government in relation to any procurement project or activity.

**10. In case advance payment was made or given, failure to perform or deliver any of the obligations and undertakings in the contract shall be sufficient grounds to constitute criminal liability for Swindling (Estafa) or the commission of fraud with unfaithfulness or abuse of confidence through misappropriating or converting any payment received by a person or entity under an obligation involving the duty to deliver certain goods or services, to the prejudice of the public and the government of the Philippines pursuant to Article 315 of Act No. 3815 s. 1930, as amended, or the Revised Penal Code.**

IN WITNESS WHEREOF, I have hereunto set my hand this \_\_\_ day of \_\_\_, 20\_\_ at \_\_\_\_\_, Philippines.

*[Insert NAME OF BIDDER OR ITS AUTHORIZED REPRESENTATIVE]*

*[Insert signatory's legal capacity]*

Affiant

**[Jurat]**

*[Format shall be based on the latest Rules on Notarial Practice]*

**BID SECURING DECLARATION FORM**

---

**REPUBLIC OF THE PHILIPPINES)**  
**CITY OF \_\_\_\_\_) S.S.**

X-----X

**BID SECURING DECLARATION**  
**SUPPLY, DELIVERY, INSTALLATION AND TESTING OF VARIOUS HEATED**  
**AIR MECHANICAL GRAIN DRYERS**  
*[PHilMech RCEF-23-11-31]*

<b>Lot no/s. being bid:</b>  _____	<b>Name and Signature of Authorized Representative:</b>  _____
--	--

To: *[Insert name and address of the Procuring Entity]*

I/We<sup>2</sup>, the undersigned, declare that:

1. I/We understand that, according to your conditions, bids must be supported by a Bid Security, which may be in the form of a Bid-Securing Declaration.
2. I/We accept that: (a) I/we will be automatically disqualified from bidding for any contract with any procuring entity for a period of two (2) years upon receipt of your Blacklisting order; and, (b) I/we will pay the applicable fine provided under Section 6 of the Guidelines on the Use of Bid Securing Declaration, within fifteen (15) days from receipt of the written demand by the procuring entity for the commission of acts resulting to the enforcement of the bid securing declaration under Sections 23.1(b), 34.2, 40.1 and 69.1, except 69.1(f), of the IRR of RA 9184; without prejudice to other legal action the government may undertake.
3. I/We understand that this Bid Securing Declaration shall cease to be valid on the following circumstances:
  - (a) Upon expiration of the bid validity period, or any extension thereof pursuant to your request;

\_\_\_\_\_

<sup>2</sup> Select one and delete the other. Adopt the same instruction for similar terms throughout the document.



- (b) I am/we are declared ineligible or post-disqualified upon receipt of your notice to such effect, and (i) I/we failed to timely file a request for reconsideration or (ii) I/we filed a waiver to avail of said right;
- (c) I am/we are declared the bidder with the Lowest Calculated Responsive Bid, and I/we have furnished the performance security and signed the Contract.

IN WITNESS WHEREOF, I/We have hereunto set my/our hand/s this \_\_\_\_ day of [month] [year] at [place of execution].

*[Insert NAME OF BIDDER'S AUTHORIZED REPRESENTATIVE]*  
*[Insert Signatory's Legal Capacity]*  
 Affiant

**SUBSCRIBED AND SWORN** to before me this \_\_\_\_ day of [month] [year] at [place of execution], Philippines. Affiant/s is/are personally known to me and was/were identified by me through competent evidence of identity as defined in the 2004 Rules on Notarial Practice (A.M. No. 02-8-13-SC). Affiant/s exhibited to me his/her [insert type of government identification card used], with his/her photograph and signature appearing thereon, with no. \_\_\_\_\_ and his/her Community Tax Certificate No. \_\_\_\_\_ issued on \_\_\_\_ at \_\_\_\_\_.

Witness my hand and seal this \_\_\_\_ day of [month] [year].

**NAME OF NOTARY PUBLIC**  
 Serial No. of Commission \_\_\_\_\_  
 Notary Public for \_\_\_\_\_ until \_\_\_\_\_  
 Roll of Attorneys No. \_\_\_\_\_  
 PTR No. \_\_\_\_\_ [date issued], [place issued]  
 IBP No. \_\_\_\_\_ [date issued], [place issued]

Doc. No. \_\_\_\_\_  
 Page No. \_\_\_\_\_  
 Book No. \_\_\_\_\_  
 Series of \_\_\_\_\_

**SUPPLY, DELIVERY, INSTALLATION AND TESTING OF VARIOUS HEATED  
AIR MECHANICAL GRAIN DRYERS**  
[PHilMech RCEF-23-11-31]

<b>Lot no/s. being bid:</b>  _____	<b>Name and Signature of Authorized Representative:</b>  _____
--	--

**Statement of All Ongoing Government and Private Contracts, including contracts  
awarded but not yet started, if any and delivered but not yet inspected and accepted**

Name of Client	Name of the Contract	Date and status of the Contract	Kinds of Goods	Amount of Contract	Value of Outstanding Contracts	Date of Delivery	Purchase Order Number/s or Date of Contract/s

**CERTIFIED CORRECT:**

\_\_\_\_\_  
Name & Signature of Authorized Representative

\_\_\_\_\_  
Position

\_\_\_\_\_  
Date

**SUPPLY, DELIVERY, INSTALLATION AND TESTING OF VARIOUS HEATED  
AIR MECHANICAL GRAIN DRYERS**  
*[PHilMech RCEF-23-11-31]*

<b>Lot no/s. being bid:</b>  _____	<b>Name and Signature of Authorized Representative:</b>  _____
--	--

**Statement of Single Largest Completed Contract of Similar Nature within the Last Ten  
(10) Years from date of Submission and Receipt of Bids**

Name of Client	Name of the Contract	Date of the Contract	Kinds of Goods	Amount of Contract	Date of Delivery	Official Receipt No. & Date, End User's Acceptance Date OR Collection Receipt

**CERTIFIED CORRECT:**

\_\_\_\_\_  
Name & Signature of Authorized Representative

\_\_\_\_\_  
Position

\_\_\_\_\_  
Date

**SUPPLY, DELIVERY, INSTALLATION AND TESTING OF VARIOUS HEATED  
AIR MECHANICAL GRAIN DRYERS**  
[PHilMech RCEF-23-11-31]

<b>Lot no/s. being bid:</b> <hr style="border: 0; border-top: 1px solid black;"/>	<b>Name and Signature of Authorized Representative:</b> <hr style="border: 0; border-top: 1px solid black;"/>
<b>Total ABC (₱) of all the Lots being Bid:</b>	<b>PhP</b> <hr style="border: 0; border-top: 1px solid black;"/>

**CERTIFICATE OF NET FINANCIAL CONTRACTING CAPACITY**  
**(Please show figures at how you arrived at the NFCC)**

This is to certify that our Net Financial Contracting Capacity (NFCC) is **Philippine Peso**  
 (₱ 

---

) which is at least equal to the ceiling price we are bidding. The amount is computed as follows:

<b>CA</b>	=	Current Assets	₱	
<b>Less:</b>			-	
<b>CL</b>	=	Current Liabilities		
		<b>Sub Total 1</b>	₱	
			<b>X 15</b>	
		<b>Sub Total 2</b>	₱	
<b>Less:</b>			-	
			₱	
<b>C</b>	=	value of all outstanding or uncompleted portions of the projects under on-going contracts, including awarded contracts yet to be started coinciding with the contract for this Project		
		<b>NFCC</b>	₱	

Issued this \_\_\_\_\_ day of \_\_\_\_\_, 2023.

---

  
Name & Signature of Authorized Representative

---

  
Position

---

  
Date

**Notes:**

1. The values of the bidder's current assets and current liabilities shall be based on the latest Audited Financial Statements submitted to the BIR.
2. The value of the outstanding or uncompleted contracts refers to those listed in the Statement of All Ongoing Government and Private Contracts, Including contracts awarded but not yet started.
3. The detailed computation must be shown using the required formula provided above.
4. The NFCC must be at least be equal to the ABC of the Project

(Name of Bank)

**COMMITTED LINE OF CREDIT**

Date: \_\_\_\_\_

**PHILIPPINE CENTER FOR POSTHARVEST DEVELOPMENT AND MECHANIZATION**

CLSU Compound, Science City of Muñoz  
Nueva Ecija

CONTRACT/PROJECT	:	_____
LOT NO.	:	_____
COMPANY/FIRM	:	_____
ADDRESS	:	_____
BANK/FINANCING INSTITUTION	:	_____
ADDRESS	:	_____
AMOUNT	:	_____

This is to certify that the above Bank/Financing Institution with business address indicated above, has granted the (Supplier/Distributor/Manufacturer/Contractor), a credit line in the amount specified above which shall be used to finance the performance of the above-mentioned contract.

The credit shall be available from (date of bid submission) and such line of credit shall be maintained until issuance of Certificate of Acceptance of the goods/services subject of the Contract/project by PHilMech Representatives.

This Certification is being issued in favor of said (Supplier/ Distributor /Manufacturer/ Contractor) in connection with the bidding requirement of the Philippine Center for Postharvest Development and Mechanization (PHilMech) for the above-mentioned Contract/Project. We are aware that any false statement issued by us will make us liable for perjury.

This committed line of credit cannot be terminated or cancelled without the prior written approval of Philippine Center for Postharvest Development and Mechanization (PHilMech).

\_\_\_\_\_  
Name and Signature of Authorized Financing Institution Office

\_\_\_\_\_  
Official Designation

**Concurred by:**

\_\_\_\_\_  
Name & Signature of (Supplier/Distributor/Manufacture/Contractor) Authorized Representative

\_\_\_\_\_  
Official Designation

SUBSCRIBED AND SWORN TO BEFORE ME this \_\_\_\_\_ day of \_\_\_\_\_ at \_\_\_\_\_, Philippines. Affiant exhibited to me his/her competent Evidence of Identity (as defined by the 2004 Rules on Notarial Practice \_\_\_\_\_ issued \_\_\_\_\_ at \_\_\_\_\_, Philippines.

**NOTARY PUBLIC**

Doc. No.	:	_____
Page No.	:	_____
Book No.	:	_____
Series of	:	_____

## PREPARATION OF BID ENVELOPE

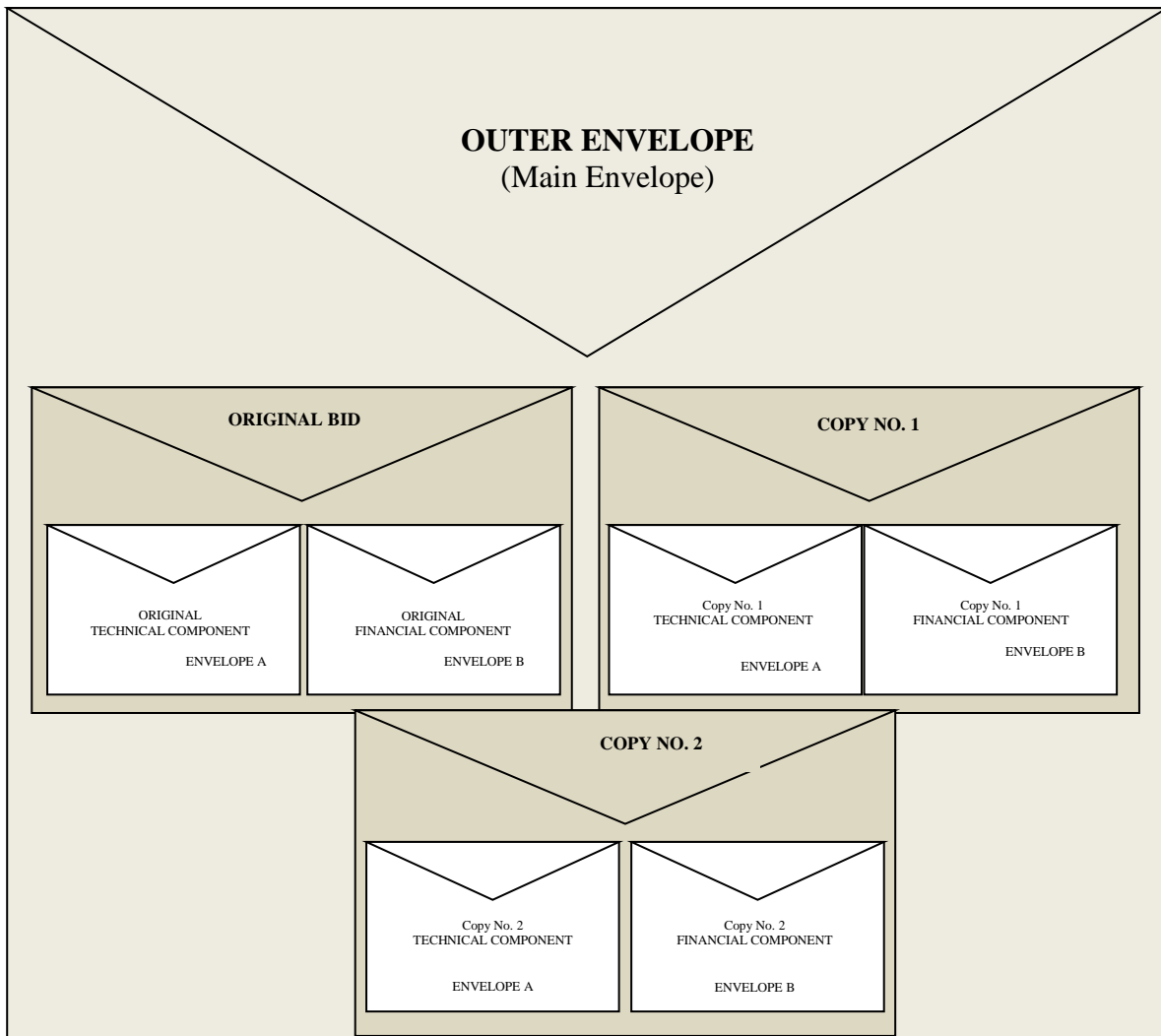

**All envelopes shall be marked in accordance with Section 15 of the Instruction to Bidders (ITB) of this Bidding Documents.**

**ANNEX A. LOT AGGREGATION & LIST OF RECIPIENTS**



